

---

# ANESTHESIA MACHINE; ANESTHESIA WORKSTATION AND DELIVERY SYSTEMS

PROF : SUBHI AL-GHANEM  
PROFESSOR OF ANESTHESIA AND ICU  
FACULTY OF MEDICINE  
THE UNIVERSITY OF JORDAN

# OUTLINE

- Anesthesia machine
- Pipeline gas supply
- Gas cylinders
- Flowmeters
- Vaporizers
- Mapilson breathing system
- Circle system
- Manual resuscitator
- Ventilators
- Scavenging system

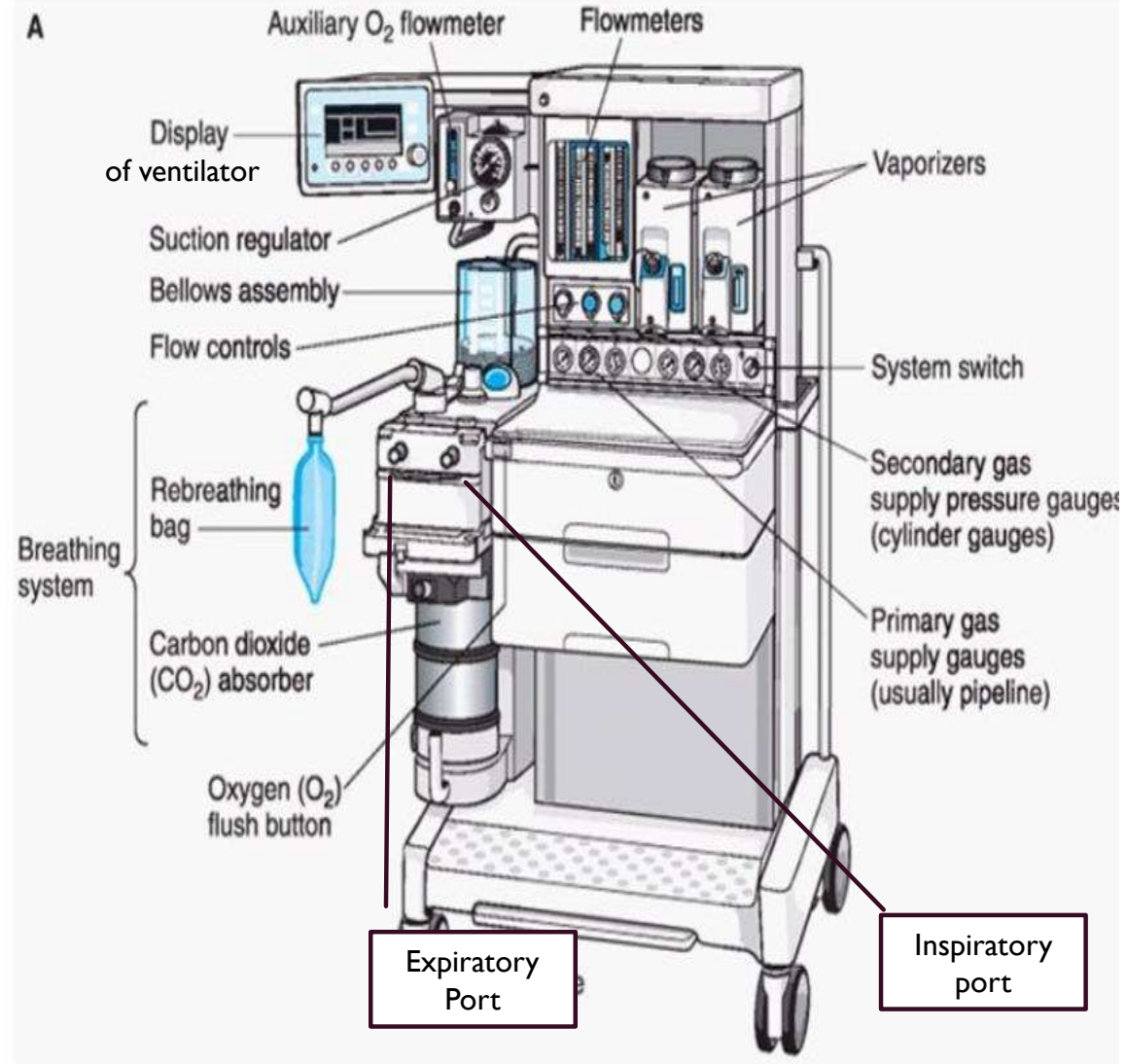
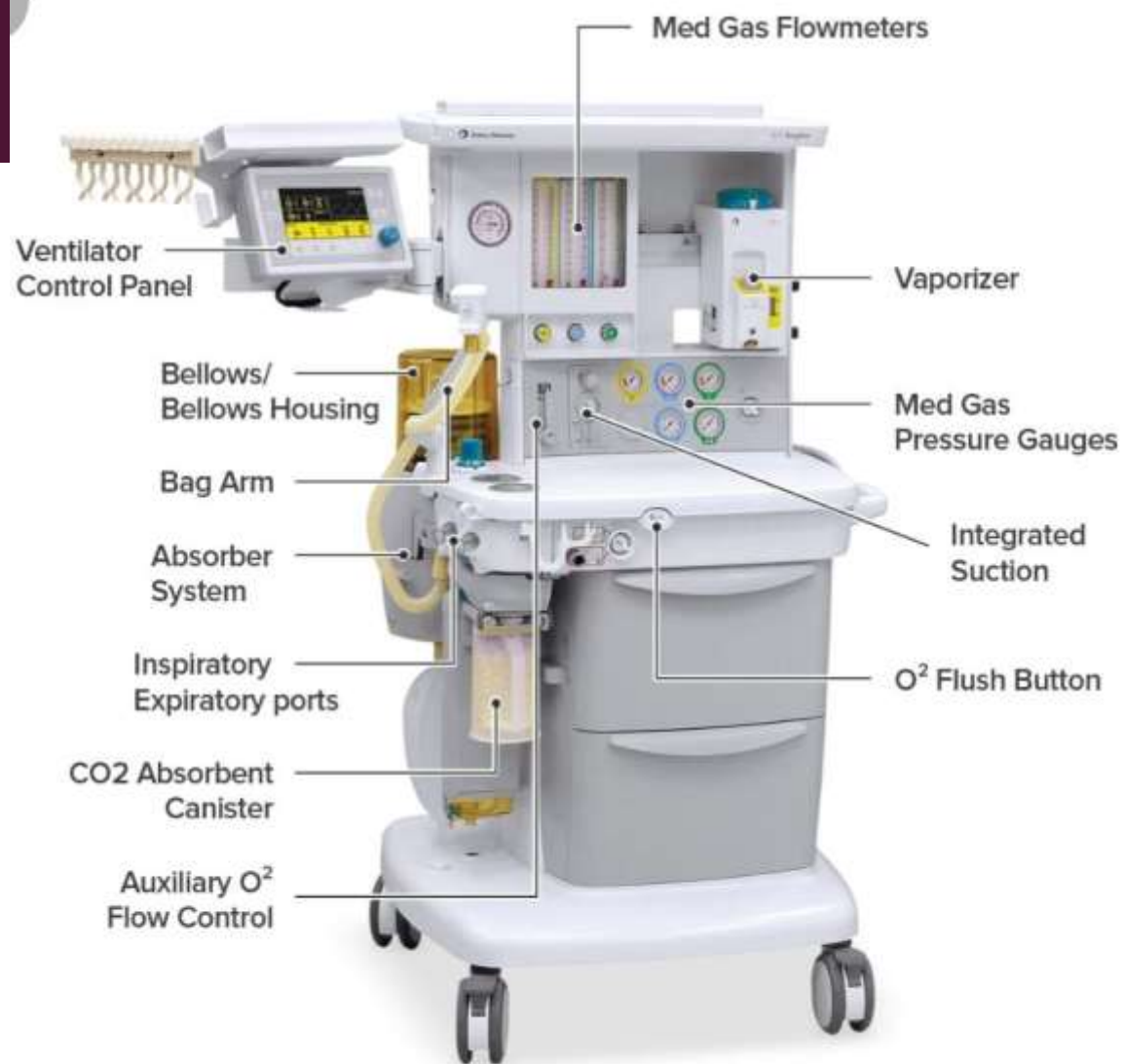
# ANESTHESIA MACHINE

- The anesthesia machine is, conceptually, a pump for delivering medical gases and inhalation agents to the patient's lungs.
- The function of the anesthesia machine is to :
  - (1) receive gases from the central supply and cylinders
  - (2) meter them and add anesthetic vapors
  - (3) deliver them to the patient breathing circuit.

This machine has evolved over the past 160 years from a rather simple ether inhaler to a complex device of valves, pistons, vaporizers, monitors, and electronic circuitry. The “pump” in the modern anesthesia machine is either a mechanical ventilator or the lungs of the spontaneously breathing patient, or perhaps, a combination of the two.

# ANESTHESIA MACHINE

- Anesthesia pump has a supply system: medical gases from either a pipeline supply or a gas cylinder, alongside vaporizers delivering potent inhaled anesthetic agents that are mixed with the medical gases. The anesthesia pump also has an exhaust system, the waste gas scavenging system, which removes excess gases from the patient's breathing circuit. The breathing circuit is a series of hoses, valves, filters, switches, and regulators that interconnect the supply system, the patient, and the exhaust system. Modern anesthesia machines are now more properly referred to as anesthesia workstations.



# STANDARDS FOR ANESTHESIA MACHINES AND WORKSTATIONS

- The American National Standards Institute (ANSI) and the American Society for Testing and Materials (ASTM) define standards for anesthesia machines and workstations, and provide guidelines to manufacturers regarding their minimum performance, design characteristics, and safety requirements.
- Newly manufactured workstations must have monitors that measure the following parameters: continuous breathing system pressure, exhaled tidal volume, ventilatory CO<sub>2</sub> concentration, anesthetic vapor concentration, inspired oxygen concentration, oxygen supply pressure, arterial hemoglobin oxygen saturation, arterial blood pressure, and continuous electrocardiogram.
- The anesthesia workstation must have a prioritized alarm system that groups the alarms into three categories: high, medium, and low priority. These monitors and alarms may be enabled automatically and made to function by turning on the anesthesia workstation, or the monitors and alarms can be enabled manually .

# GAS SUPPLIES

- Bulk Supply of Anaesthetic Gases In the majority of modern hospitals, piped medical gases and vacuum (PMGV) systems have been installed. These obviate the necessity for holding large numbers of cylinders in the operating theatre suite.
- Normally, only a few cylinders are kept in reserve, attached usually to the anaesthetic machine. The advantages of the PMGV system are reductions in cost, in the necessity to transport cylinders and in accidents caused by cylinders becoming exhausted.
- The PMGV services comprise five sections:
  - bulk store
  - distribution pipelines in the hospital
  - terminal outlets, situated usually on the walls or ceilings of the operating theatre suite and other sites
  - flexible hoses connecting the terminal outlets to the anaesthetic machine
  - connections between flexible hoses and anaesthetic machines.

# BULK STORE ; OXYGEN SUPPLY

- Oxygen may be supplied to the PMGV from a bank of several oxygen cylinders attached to a manifold. Oxygen cylinder manifolds consist of two groups of large cylinders (size J). The two groups alternate in supplying oxygen to the pipelines.
- In both groups, all cylinder valves are open so that they empty simultaneously. All cylinders have non-return valves. The supply automatically changes from one group to the other when the first group of cylinders is nearly empty. The changeover also activates an electrical signalling system, which alerts staff to change the empty cylinders.

However, in larger hospitals, pipeline oxygen originates from a liquid oxygen store. Liquid oxygen is stored at a temperature of approximately  $-165\text{ }^{\circ}\text{C}$  at 10.5 bar – a vacuum insulated evaporator (VIE).

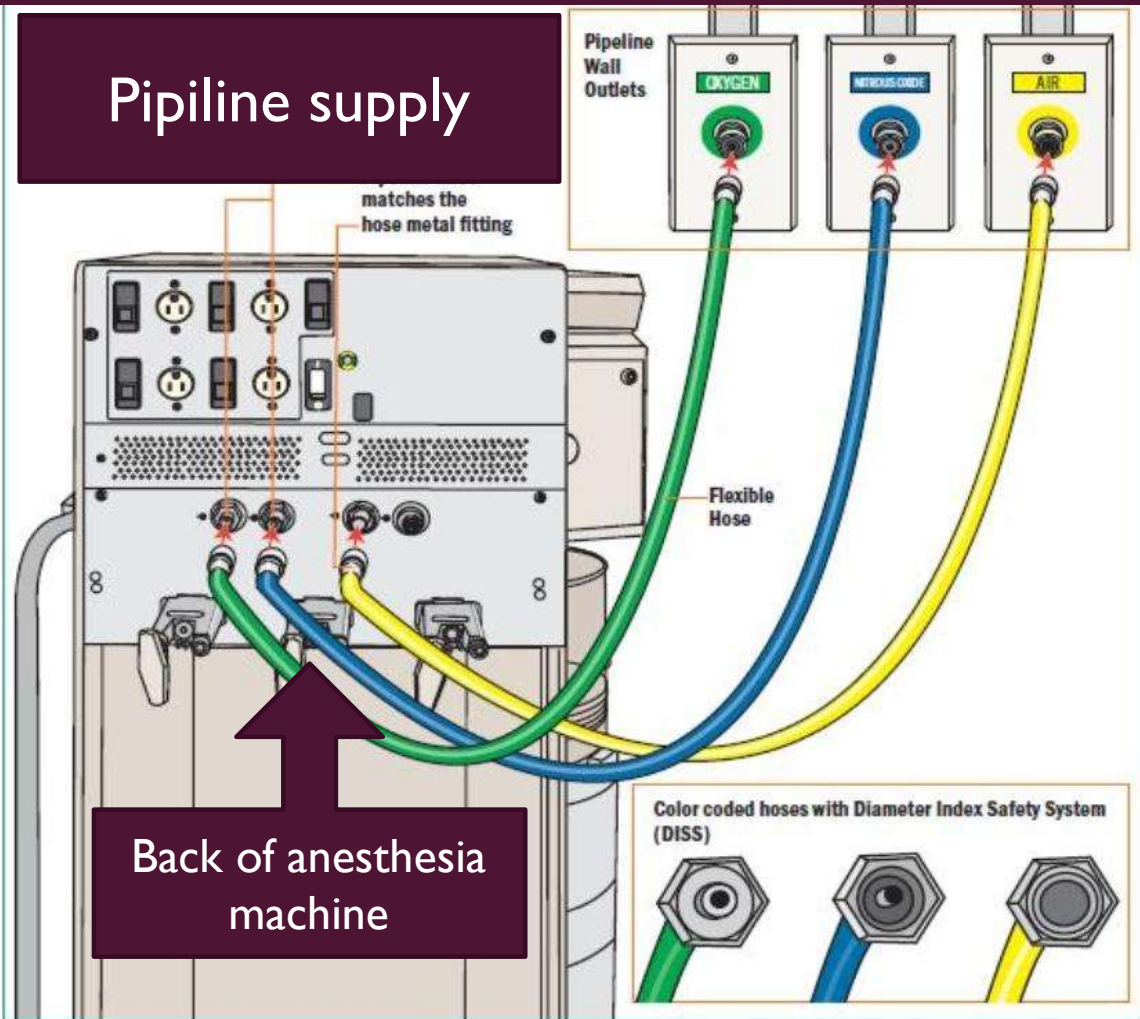
Some heat passes from the environment through the insulating layer between the two shells of the flask, increasing the tendency to evaporation and pressure increase within the chamber. Pressure is maintained constant by transfer of gaseous oxygen into the pipeline system (via a warming device). However, if the pressure increases above 17 bar (1700 kPa), a safety valve opens and oxygen runs to waste. When the supply of oxygen resulting from the slow evaporation from the surface in the VIE is inadequate, the pressure decreases and a valve opens to allow liquid oxygen to pass into an evaporator, from which gas passes into the pipeline system. Liquid oxygen plants are housed some distance away from hospital buildings because of the risk of fire. Even when a hospital possesses a liquid oxygen plant, it is still necessary to hold reserve banks of oxygen cylinders in case of supply failure.



## PIPELINE SUPPLY SOURCE

- Most hospitals today have a central piping system to deliver medical gases including oxygen, nitrous oxide, and air to outlets in the operating room. The central piping system must supply the correct gases at the appropriate pressure for the anesthesia workstation to function properly.
- The wall outlet connections for pipeline gases are gas-specific. If they are “quick connect” fittings then they are gas-specific within the same manufacturer.
- nationally standardized Diameter Index Safety System (DISS) provides threaded, noninterchangeable connections for medical gas lines, which minimizes the risk of misconnection. Regardless of which type of gas-specific connector (DISS or “quick connect”) exists at the wall end of the hose conducting gas to the anesthesia machine, the gas enters the anesthesia machine through DISS inlet connections. A pressure gauge measures the pipeline gas pressure when the machine is connected to a pipeline supply. A check valve is located downstream from the inlet. It prevents reverse flow of gases from the machine to the pipeline or the atmosphere.

Pipeline supply



Back of anesthesia machine



# COLOR CODING OF HOSES INSIDE OR

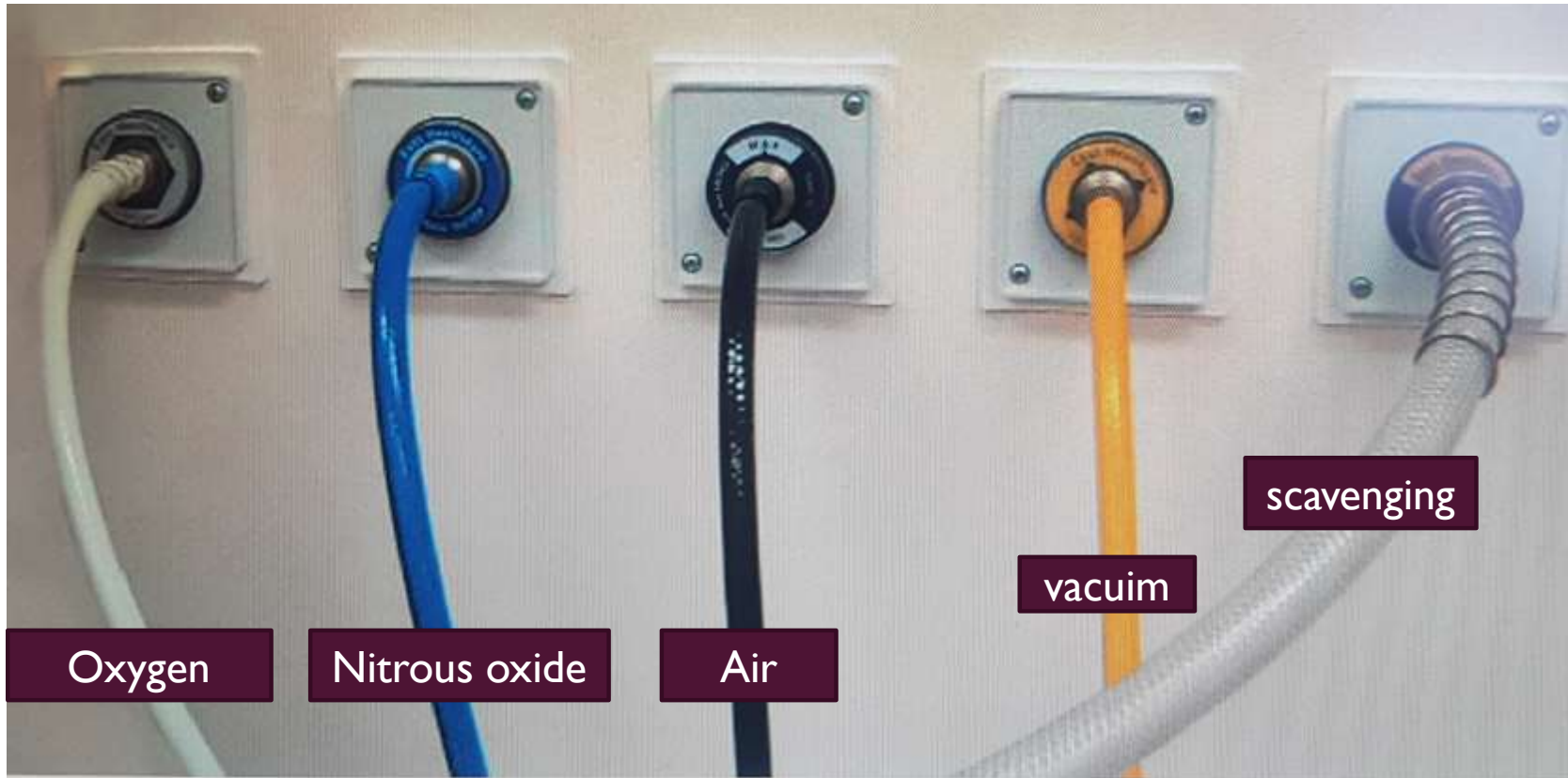


Figure 1.28 Colour-coded hoses.

# COLOR CODING OF TERMINAL OUTLETS OF GASES IN OR



# PIPELINE SUPPLY SOURCE

- Nitrous Oxide

Nitrous oxide and Entonox may be supplied from banks of cylinders connected to manifolds similar to those used for oxygen.

- Medical Compressed Air

Compressed air is supplied from a bank of cylinders into the PMGV system. Air of medical quality is required, as industrial compressed air may contain fine particles of oil.

- Piped Medical Vacuum:

Piped medical vacuum is provided by large vacuum pumps which discharge via a filter and silencer to a suitable point, usually at roof level, where gases are vented to atmosphere.

# TERMINAL OUTLETS

- Vacuum (coloured yellow) – a vacuum of at least 53 kPa (400 mmHg) should be maintained at the outlet, which should be able to take a free flow of air of at least 40 L/ min
- Compressed air (coloured white/black) at 4 bar – this is used for anaesthetic breathing systems and ventilators.
- Air (coloured white/black) at 7 bar – this is to be used only for powering compressed air tools and is confined usually to the orthopaedic operating theatre.
- Nitrous oxide (coloured blue) at 4 bar.
- Oxygen (coloured white) at 4 bar.
- Scavenging – there is a variety of scavenging outlets from the operating theatre. The passive systems are designed to accept a standard 30-mm connection.

## TERMINAL OUTLETS

- Whenever a new pipeline system has been installed or servicing of an existing pipeline system has been undertaken, a designated member of the pharmacy staff should test the gas obtained from the sockets, using an oxygen analyser. Malfunction of an oxygen/ air mixing device may result in entry of compressed air into the oxygen pipeline, rendering an anaesthetic mixture hypoxic. Because of this and other potential mishaps, oxygen analysers should be used routinely during anaesthesia.



# CYLINDERS

- Modern cylinders are constructed from molybdenum steel. They are checked at intervals by the manufacturer to ensure that they can withstand hydraulic pressures considerably in excess of those to which they are subjected in normal use.
- One cylinder in every 100 is cut into strips to test the metal for tensile strength, flattening impact and bend tests. Medical gas cylinders are tested hydraulically every 5 years and the tests recorded by a mark stamped on the neck of the cylinder and this includes test pressure, dates of test performed, chemical formula of the cylinder's content and the tare weight. Cylinders may also be inspected endoscopically or ultrasonically for cracks or defects on their inner surfaces. Light weight cylinders can be made from aluminium alloy with a fibreglass covering in an epoxy resin matrix. The cylinders are provided in a variety of sizes (A to J), and colour-coded according to the gas supplied. Cylinders attached to the anaesthetic machine are usually size E. The cylinders comprise a body and a shoulder containing threads into which are fitted a pin index valve block, a bull-nosed valve or a handwheel valve. The pin index system was devised to prevent interchangeability of cylinders of different gases. Pin index systems are provided for the smaller cylinders of oxygen and nitrous oxide (and also carbon dioxide) which may be attached to anaesthetic machines. The pegs on the inlet connection slot into corresponding holes on the cylinder valve.



# CYLINDERS

- The colour codes used for medical gas cylinders in the United Kingdom. Different colours are used for some gases in other countries. There is a proposal to harmonize cylinder colours throughout Europe. The body will be painted white and only the shoulders will be colour-coded. The shoulder colours for medical gases will correspond to the current UK colours but will be horizontal rings rather than quarters
- .Oxygen, air and helium are stored as gases in cylinders and the cylinder contents can be estimated from the cylinder pressure. The pressure gradually decreases as the cylinder empties.

# CYLINDERS

















- Nitrous oxide and carbon dioxide cylinders contain liquid and vapour and the cylinders are filled to a known filling ratio. The cylinder pressure cannot be used to estimate its contents because the pressure remains relatively constant until after all the liquid has evaporated and the cylinder is almost empty, though cylinder pressure may change slightly due to temperature changes during use. The contents of nitrous oxide and carbon dioxide cylinders can be estimated from the weight of the cylinder.
- Nitrous oxide (N<sub>2</sub>O) can be supplied to the anesthesia machine from the pipeline system at a pressure of approximately 50 psig or from a backup E-cylinder in the N<sub>2</sub>O hanger yoke. N<sub>2</sub>O has a molecular weight of 44 atomic mass units (AMU) and a boiling point of 88°C at 760 mm Hg (14.7 psia) pressure.<sup>47</sup> The critical temperature (CT) is the highest temperature at which a gas can exist in liquid form. The CT of N<sub>2</sub>O is 36.5°C (critical pressure: 1,054 psig), therefore N<sub>2</sub>O can exist as a liquid at room temperature (20°C

# CYLINDERS

E- cylinders of N<sub>2</sub>O are factory-filled to 90% to 95% capacity with liquid N<sub>2</sub>O. Above the liquid in the tank is N<sub>2</sub>O vapor. Because the liquid agent is in equilibrium with its vapor or gas phase, the pressure exerted by the gaseous N<sub>2</sub>O is its saturated vapor pressure (SVP) at the ambient temperature. At 20°C, the SVP of N<sub>2</sub>O is 750 psig. A full E-tank of N<sub>2</sub>O generates approximately 1,600 L of gas at 1 atm pressure at sea level (14.7 psia). As long as some liquid N<sub>2</sub>O is present in the tank and the ambient temperature remains at 20°C, the pressure in the N<sub>2</sub>O tank will remain at 750 psig, which is the SVP of N<sub>2</sub>O at 20°C. The volume of N<sub>2</sub>O gas available from a tank therefore cannot be determined by reference to the N<sub>2</sub>O tank pressure gauge. It is determined by weighing the tank and subtracting the weight of the empty tank (tare weight) to determine the weight of the contained N<sub>2</sub>O. When the tank pressure is 750 psig from gas only, and the internal volume of the E-cylinder is 4.8 L, the volume of N<sub>2</sub>O available at a pressure of 1 atm (i.e., 760 mm Hg or 14.7 psia) is 250 L. At this point the N<sub>2</sub>O tank is 250/1,600, or 16%, full. From then on, as N<sub>2</sub>O continues to be utilized, the value on the tank pressure gauge will fall.

## Medical Gas Cylinders Used Currently (2013) in the UK

	COLOUR		PRESSURE AT 15 °C		
	<i>Body</i>	<i>Shoulder</i>	<i>lb in<sup>-2</sup></i>	<i>kPa</i>	<i>Bar</i>
Oxygen	Black	White	1987	13700	137
Nitrous oxide	Blue	Blue	638	4400	44
CO <sub>2</sub>	Grey	Grey	725	5000	50
Helium	Brown	Brown	1987	13700	137
Air	Grey	White/black quarters	1987	13700	137
O <sub>2</sub> /helium	Black	White/brown quarters	1987	13700	137
N <sub>2</sub> O/O <sub>2</sub> (Entonox)	Blue	White/blue quarters	1987	13700	137

Gas	Identification markings on cylinder shoulder		
Oxygen			White
Nitrous oxide			Blue
Entonox (50% N <sub>2</sub> O/50% O <sub>2</sub> )			Blue/white
Air			Black/white
Oxygen/carbon dioxide mixture (95% O <sub>2</sub> /5% CO <sub>2</sub> )			Grey/white
Helium/oxygen mixture (79% He/21% O <sub>2</sub> )			Brown/white
Carbon dioxide			Grey
Helium			Brown



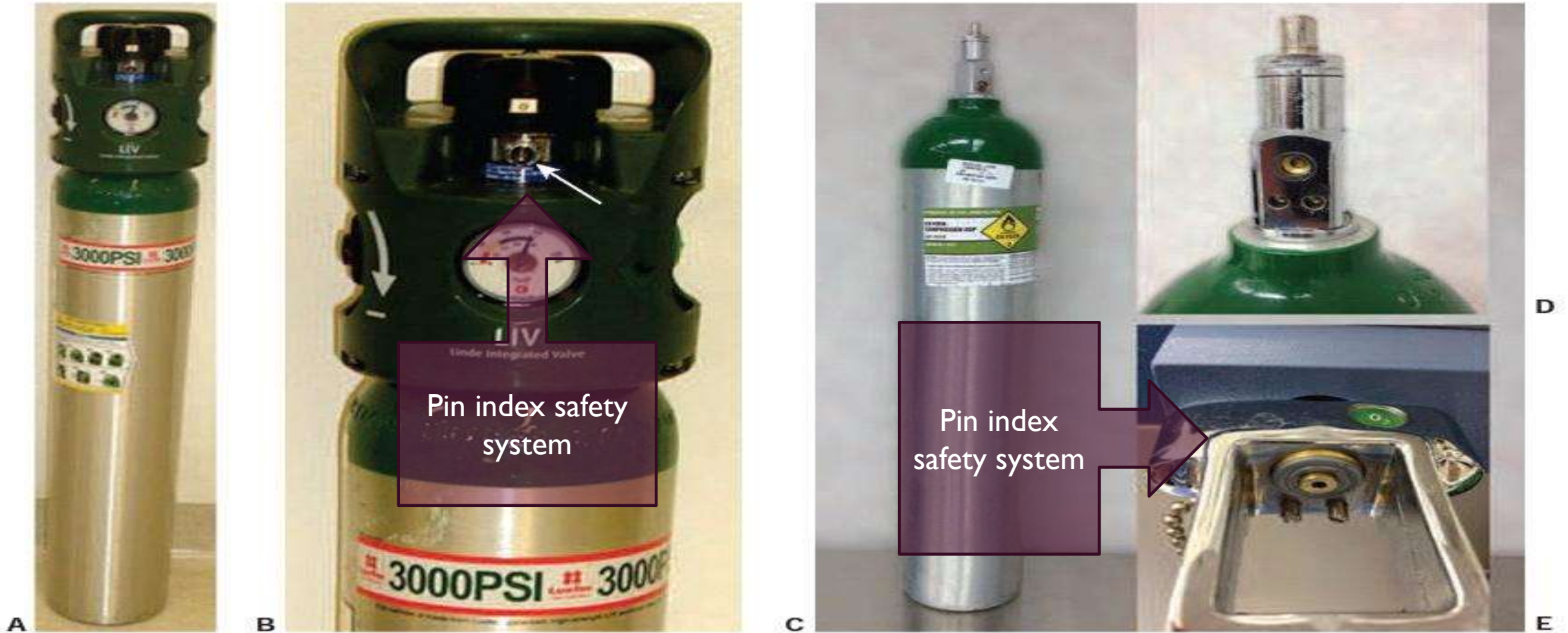
# GAS CYLINDERS –COLOR CODING SYSTEMS – US VS UK

Gas cylinder	Color (US)	Color ISO (UK)	
Oxygen	Green	White	
Air	Yellow	Black &	White
Nitrous oxide	Blue	Blue	
Entonox® (50/50% O2/N2O)	Not available	Blue &	White
Heliox (21/79% Helium/O2)	Brown & White	Brown &	White

## Medical Gas Cylinder Sizes and Capacities by Cylinder Size (A–J) and Height (inches)

### CAPACITIES (L)

	<i>A/10 in</i>	<i>B/10 in</i>	<i>C/14 in</i>	<i>D/18 in</i>	<i>E/31 in</i>	<i>F/34 in</i>	<i>G/49 in</i>	<i>J/57 in</i>
Oxygen			170	340	680	1360	3400	6800
Nitrous oxide			450	900	1800	3600	9000	
CO <sub>2</sub>			450	900	1800			
Helium				300		1200		
Air							3200	6400
O <sub>2</sub> /helium					600	1200		
O <sub>2</sub> /CO <sub>2</sub>						1360	3400	
Entonox							3200	6400



**FIGURE 24-8.** (A) 3,000 psig E-cylinder with Linde Integrated Valve LIV (B), Linde Gas North America LLC that permits adjustable flows of  $\frac{1}{4}$  to 25 L/min from the low-pressure nozzle (B-arrow). There is also a high-pressure regulator that can supply oxygen at 50 psig via a DISS connector. Standard E-cylinder (C) showing pin-index safety system (D) and mating yoke (E).



# THE ANAESTHETIC MACHINE

- The anaesthetic machine comprises:
- a means of supplying gases either from attached cylinders or from piped medical supplies via appropriate unions on the machine
- methods of measuring flow rate of gases
- apparatus for vaporizing volatile anaesthetic agents
- breathing systems and a ventilator for delivery of gases and vapours from the machine to the patient
- apparatus for scavenging anaesthetic gases in order to minimize environmental pollution.

## SUPPLY OF GASES

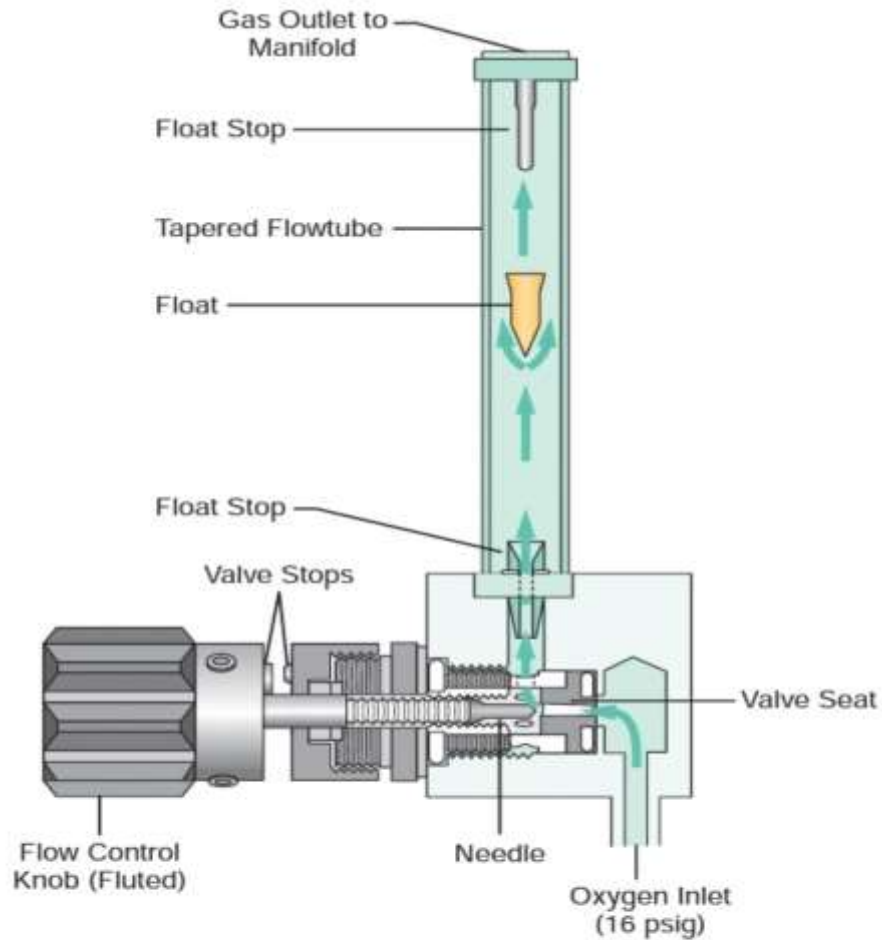
- In the UK, gases are supplied at a pipeline pressure of 4 bar (400 kPa, 60 psig) and this pressure is transferred directly to the bank of flowmeters and back bar of the anaesthetic machine. Flexible colour-coded hoses connect the pipeline outlets to the anaesthetic machine. The anaesthetic machine end of the hoses should be permanently fixed using a nut and liner union where the thread is gas-specific and non-interchangeable. The non-interchangeable screw thread (NIST) is the British Standard.
- In the United States gases are supplied at a pipeline pressure of ( 50-55 psig ) and the cylinders pressure is regulated to approximately 45 psig

# PRESSURE GAUGES AND PEESSURE REGULATORS

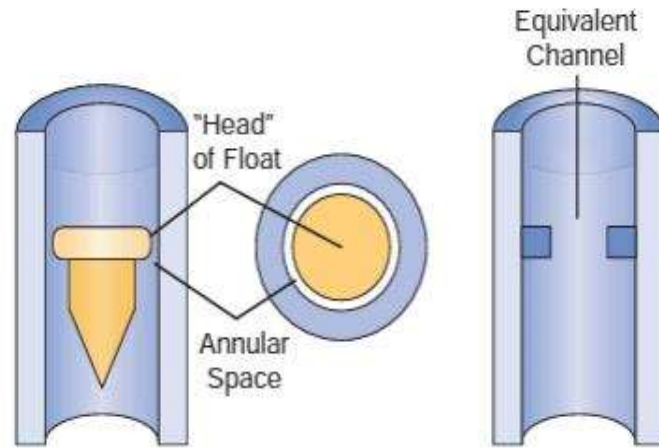
- Pressure gauges measure the pressure in the cylinders or pipeline. Anaesthetic machines have pressure gauges for oxygen, air and nitrous oxide. These are mounted usually on the front panel of the anaesthetic machine.
- Pressure Regulators :Pressure regulators are used on anaesthetic machines for three purposes:
  - to reduce the high pressure of gas in a cylinder to a safe working level
  - to prevent damage to equipment on the anaesthetic machine, e.g. flow control valves
  - as the contents of the cylinder are used, the pressure within the cylinder decreases and the regulating mechanism maintains a constant outlet pressure, obviating the necessity to make continuous adjustments to the flowmeter controls

# FLOWMETERS

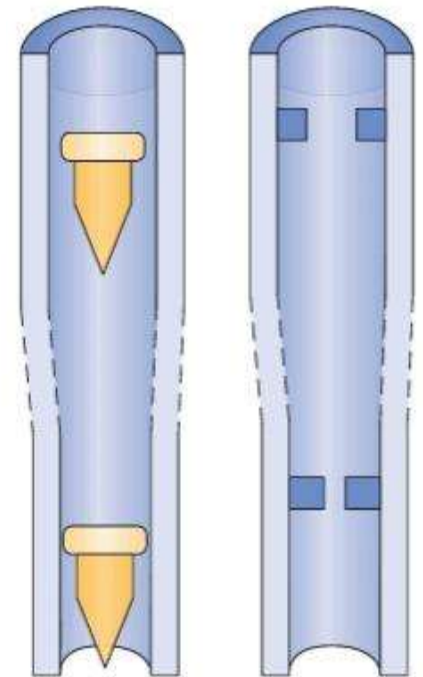
- The flowmeter assembly precisely controls and measures gas flow to the common gas outlet. With traditional glass flowmeter assemblies, the flow control needle valve regulates the amount of flow that enters a tapered, transparent flow tube known as a Thorpe tube. The tube is tapered such that it has a small cross-sectional area at its lower (low flow) end, and a larger cross-sectional area at its upper (high flow) end. A mobile indicator float inside the flow tube indicates the amount of flow passing through the associated flow control valve. The quantity of flow is indicated on a scale associated with the flow tube. Some newer anesthesia workstations have now replaced the conventional glass flow tubes with electronic flow sensors that measure the flow of the individual gases. The flow rate data are then presented in numerical format, graphical format, or a combination of the two.



**FIGURE 24-12.** Oxygen flowmeter assembly. The oxygen flowmeter assembly is composed of the flow control valve assembly plus the flowmeter subassembly. Note that this is a GE Datex-Ohmeda design because in this figure oxygen is supplied to the flowmeter at 16 psig from a second-stage regulator. (Reproduced with permission from: Bowie E, Huffman LM. *The Anesthesia Machine: Essentials for Understanding*. Madison, WI: Ohmeda, a division of BOC Health Care, Inc., 1985.)



**FIGURE 24-13.** The annular space. The clearance between the head of the float and the flow tube is known as the annular space. It can be considered equivalent to a circular channel of the same cross-sectional area. (Redrawn with permission from: Macintosh R, Mushin WW, Epstein HG. *Physics for the Anaesthetist*. 3rd ed. Oxford: Blackwell Scientific Publications; 1963.)

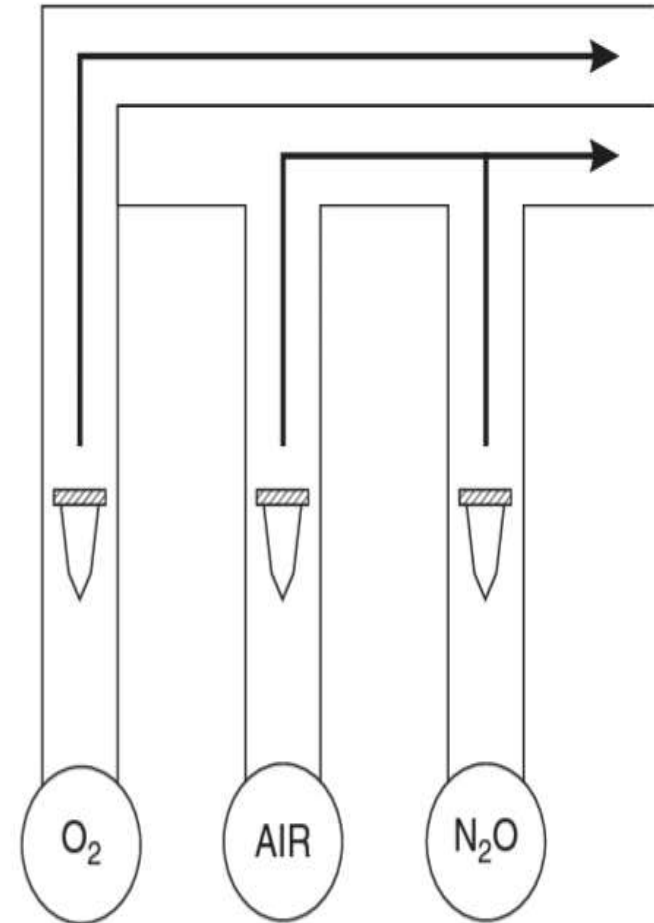


# PROBLEMS WITH FLOWMETERS

- Non-vertical tube. This causes a change in shape of the annulus and therefore variation in flow. If the bobbin touches the side of the tube, resulting friction causes an even more inaccurate reading.
- Static electricity. This may cause inaccuracy (by as much as 35%) and sticking of the bobbin, especially at low flows. This may be reduced by coating the inside of the tube with a transparent film of gold or tin.
- Dirt on the bobbin may cause sticking or alteration in size of the annulus and therefore inaccuracies.
- Back-pressure. Changes in accuracy may be produced by back-pressure. For example, the Manley ventilator may exert a back-pressure and depress the bobbin; there may be as much as 10% more gas flow than that indicated on the flowmeter. Similar problems may be produced by the insertion of any equipment which restricts flow downstream, e.g. Selectatec head, vaporizer.
- Leakage. This results usually from defects in the top sealing washer of a flowmeter.

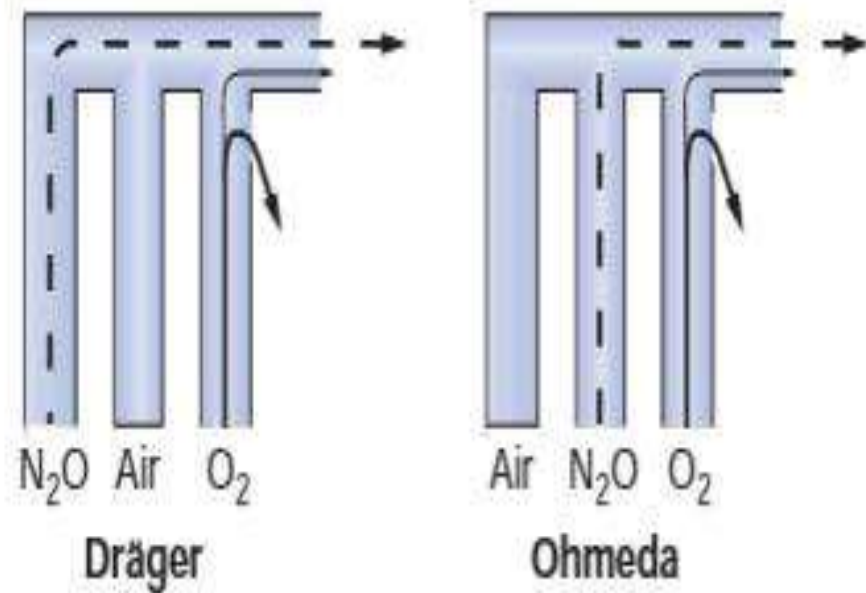
# FLOWMETERS

- It is unfortunate that, in the UK, the standard position of the oxygen flowmeters is on the left followed by either nitrous oxide or air (if all three gases are supplied). On several recorded occasions, patients have suffered damage from hypoxia because of leakage from a broken flowmeter tube in this type of arrangement, as oxygen, being at the upstream end, passes out to the atmosphere through any leak. This problem is reduced if the oxygen flowmeter is placed downstream (i.e. on the right-hand side of the bank of flowmeters) as is standard practice in the USA. In the UK, this problem is now avoided by designing the outlet from the oxygen flowmeter to enter the back bar downstream from the outlets of other flowmeters.

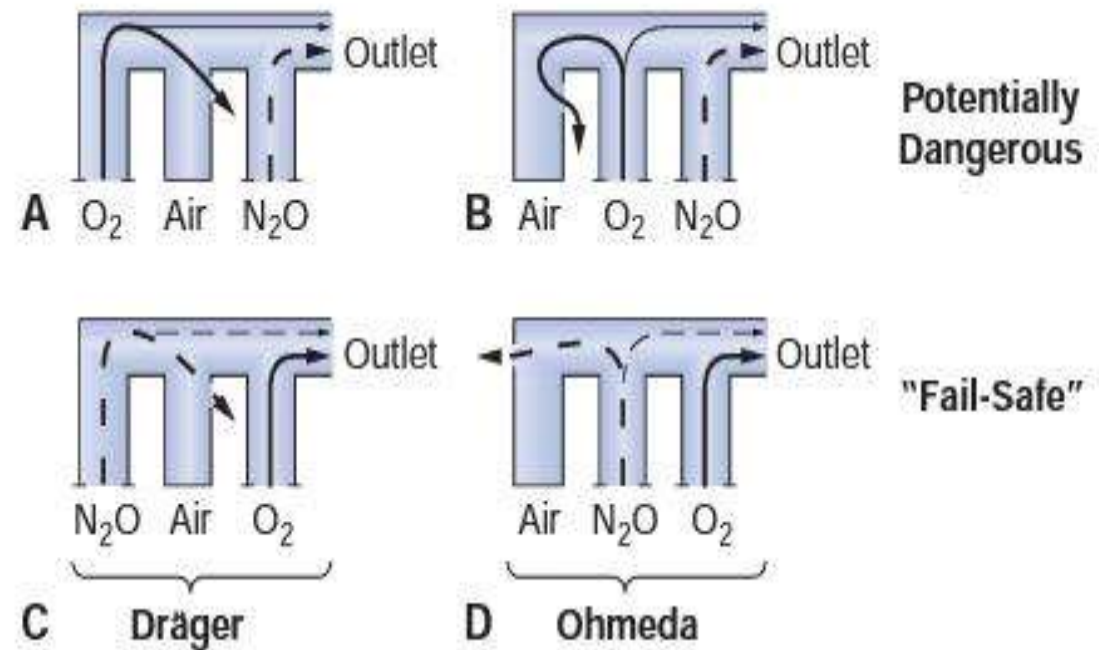


**FIGURE 15.1** ■ Oxygen is the last gas to be added to the gas mixture being delivered to the back bar.





**FIGURE 24-16.** Oxygen flow tube leak. An oxygen flow tube leak can produce a hypoxic mixture regardless of flow tube arrangement. (Reproduced with permission from: Brockwell RC. Inhaled anesthetic delivery systems. In: Miller RD, ed. *Anesthesia*. 6th ed. Philadelphia, PA: Churchill Livingstone; 2004:281.)

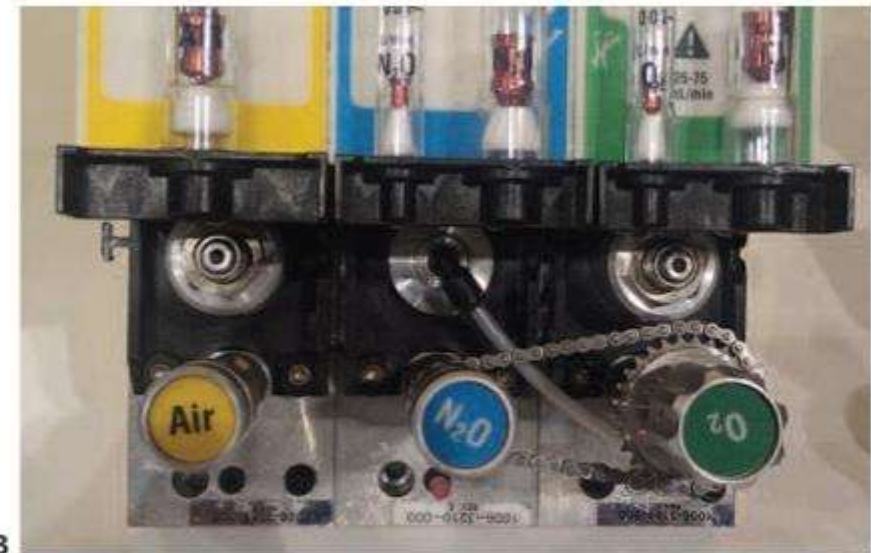
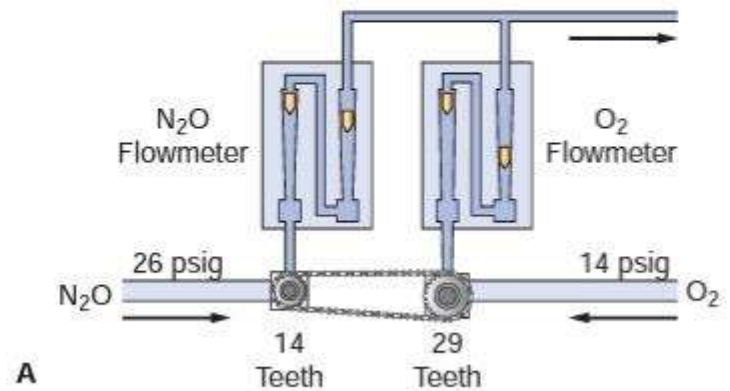


**FIGURE 24-15.** Flowmeter sequence—a potential cause of hypoxia. In the event of a flowmeter leak, a potentially dangerous arrangement exists when nitrous oxide is located in the downstream position (A and B). The safest configuration exists when oxygen is located in the downstream position (C and D). See text for details. (Modified with permission from: Eger EI 2nd, Hylton RR, Irwin RH, et al. Anesthetic flowmeter sequence—a cause for hypoxia. *Anesthesiology*. 1963;24:396.)



- Linked Flowmeters

The majority of modern anaesthetic machines such possess a mechanical linkage between the nitrous oxide and oxygen flowmeters. This causes the nitrous oxide flow to decrease if the oxygen flowmeter is adjusted to give less than 25–30% O<sub>2</sub>.



**FIGURE 24-19. A.** Schematic and **(B)** photo of Ohmeda Link-25 Proportion-Limiting Control System. See text for details.

## OXYGEN FLUSH VALVE

- The emergency oxygen flush is a non-locking button which, when pressed, delivers pure oxygen from the anaesthetic outlet. On modern anaesthetic machines, the emergency oxygen flush lever is situated downstream from the flowmeters and vaporizers. A flow of about 35–75 L /min at pipeline pressure (45-50 psig), is delivered. This may lead to dilution of the anaesthetic mixture with excess oxygen if the emergency oxygen tap is opened partially by mistake and may result in awareness. There is also a risk of barotrauma if the high pressure is accidentally delivered directly to the patient's lungs.

# VAPORIZERS

- Drawover vaporizers: . These have a very low resistance to gas flow and can be used in spontaneously breathing patient, like emergency use in the field (e.g. Oxford miniature vaporizer; OMV)

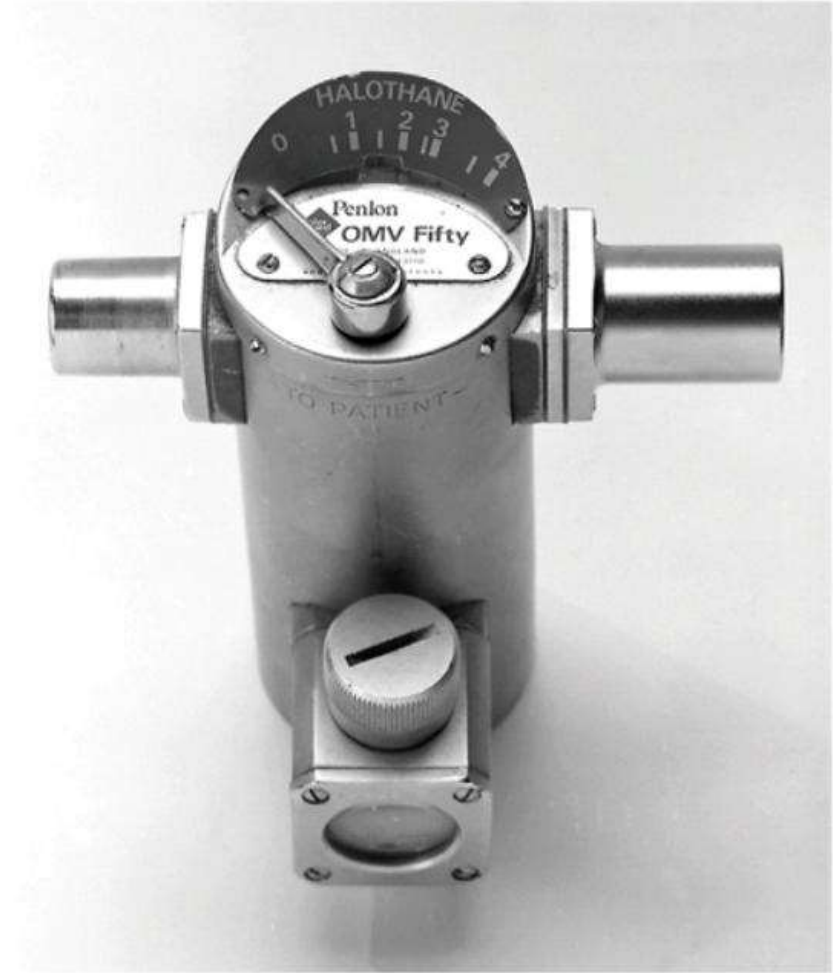


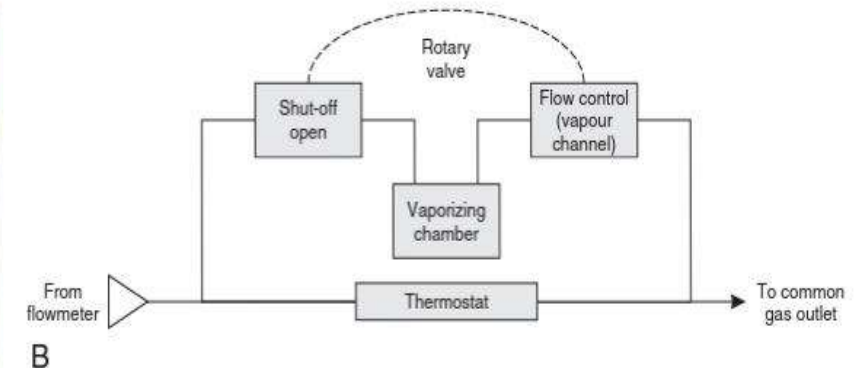
FIGURE 15.5 ■ Oxford miniature vaporizer (OMV).

# VAPORIZERS

- Plenum vaporizers. These are intended for unidirectional gas flow, have a relatively high resistance to flow and are unsuitable for use either as drawover vaporizers or in a circle system. Examples include the 'TEC' type in which there is a variable bypass flow.

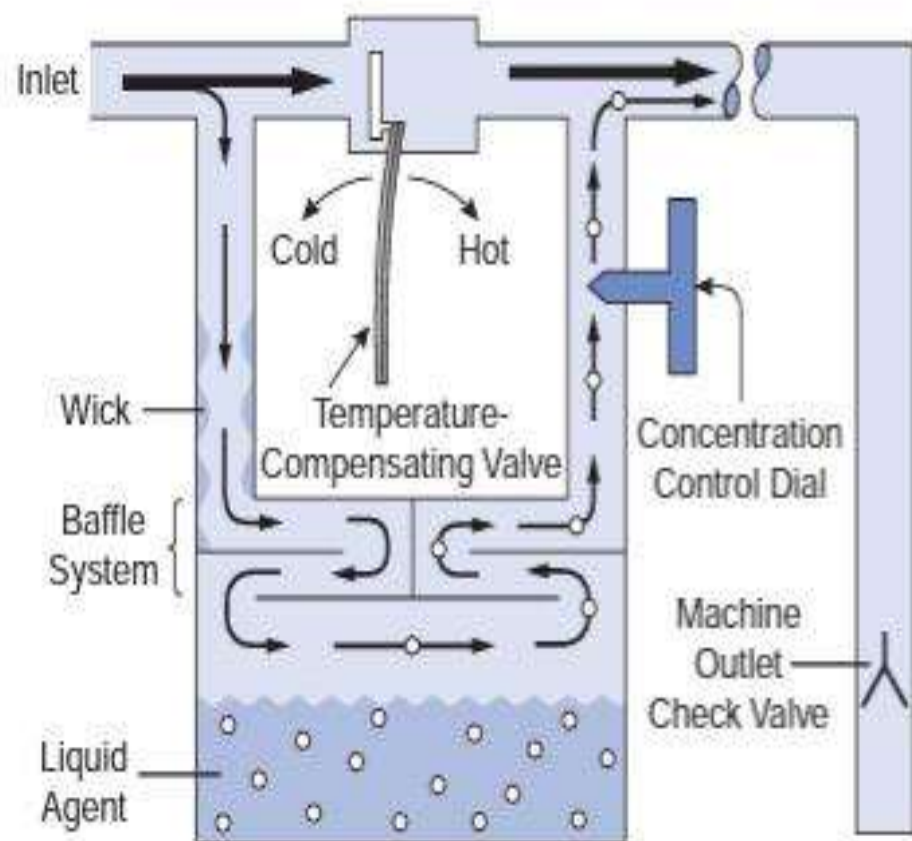


FIGURE 15.6 ■ Sevoflurane vaporizer.

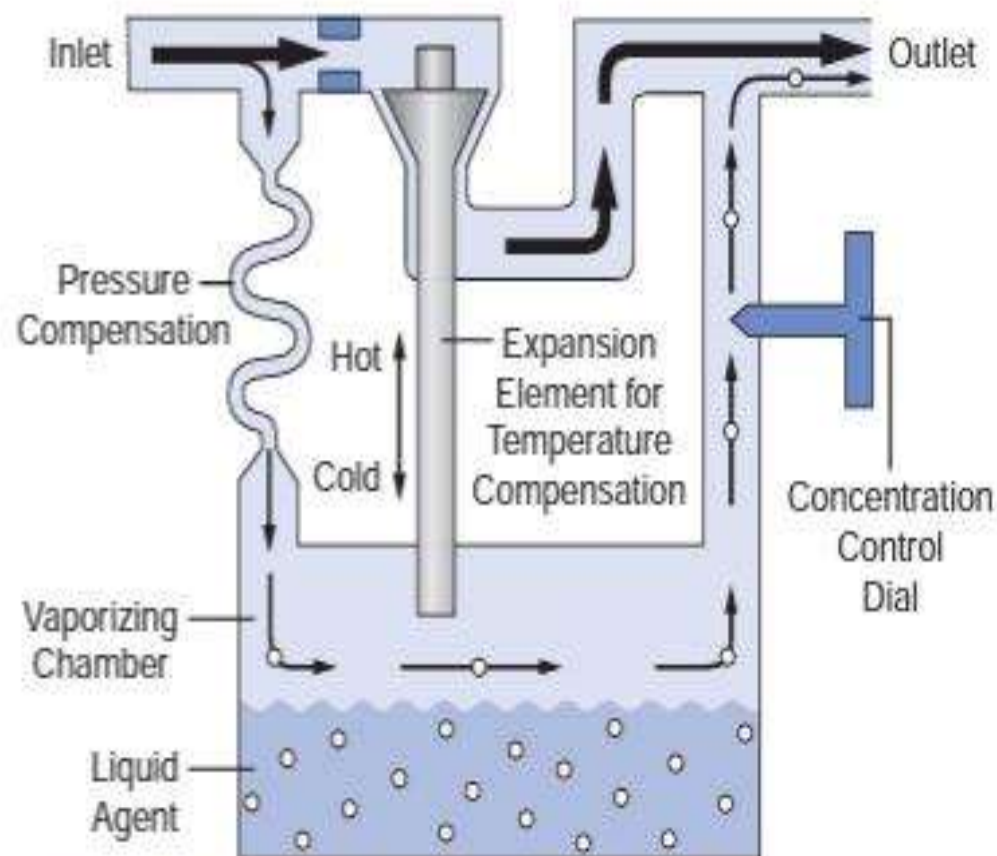


# VARIABLE BYPASS VAPORIZERS

- The **GE-Datex-Ohmeda Tec 4, Tec 5, and Tec 7**, as well as the **Dräger Vapor 19.n and 2000 series**, vaporizers are classified as variable bypass, low-over, temperature-compensated, agent-specific, out-of-breathing circuit vaporizers.
- **Variable bypass** refers to the method for regulating the anesthetic agent concentration output from the vaporizer. As fresh gas from the machine lowmeters enters the vaporizer inlet, the concentration control dial setting determines the ratio of incoming gas that flows through the bypass chamber to that entering the vaporizing chamber (sump).
- The gas channeled through the vaporizing chamber flows over a wick system saturated with the liquid anesthetic and subsequently also becomes saturated with vapor.
- Thus **flow-over** refers to the method of vaporization and is in contrast to a bubble-through system that is used in now-obsolete measured low vaporizers (e.g., Copper Kettle, Verni-Trol).
- **The temperature compensated vaporizers:** Each is equipped with an automated temperature-compensating device that helps maintain a constant vapor concentration output for a given concentration dial setting, and over a wide range of operating temperatures. These vaporizers are agent specific because each is designed to accommodate a single anesthetic agent, and out-of-circuit, that is, physically located outside of the breathing circuit. Variable bypass vaporizers are used to deliver halothane, enflurane, isoflurane, and sevoflurane, but not desflurane.



**FIGURE 24-24.** Simplified schematic of the GE-Ohmeda Tec Type Vaporizer. Note bimetallic strip temperature-compensating mechanism in the bypass chamber. See text for details.



**FIGURE 24-25.** Simplified schematic of the Dräger Vapor 19.1 vaporizer. Here an expansion element performs the same function as the bimetallic strip in the previous figure. See text for details.



## DESFLURANE VAPORIZER

- Desflurane presents a particular challenge because it has a saturated vapour pressure of 664 mmHg (89 kPa) at 20 °C and a boiling point of 23.5 °C. In order to combat this problem, a new vaporizer, the TEC 6, was developed. It is heated electrically to 39 °C with a pressure of 1550 mmHg (approx. 2 bar). The vaporizer has electronic monitors of vaporizer function and alarms. The FGF does not enter the vaporization chamber. Instead, desflurane vapour enters into the path of the FGF. A percentage control dial regulates the flow of desflurane vapour into the FGF. The dial calibration is from 1% to 18%. The vaporizer has a back-up 9 volt battery in case of mains failure.

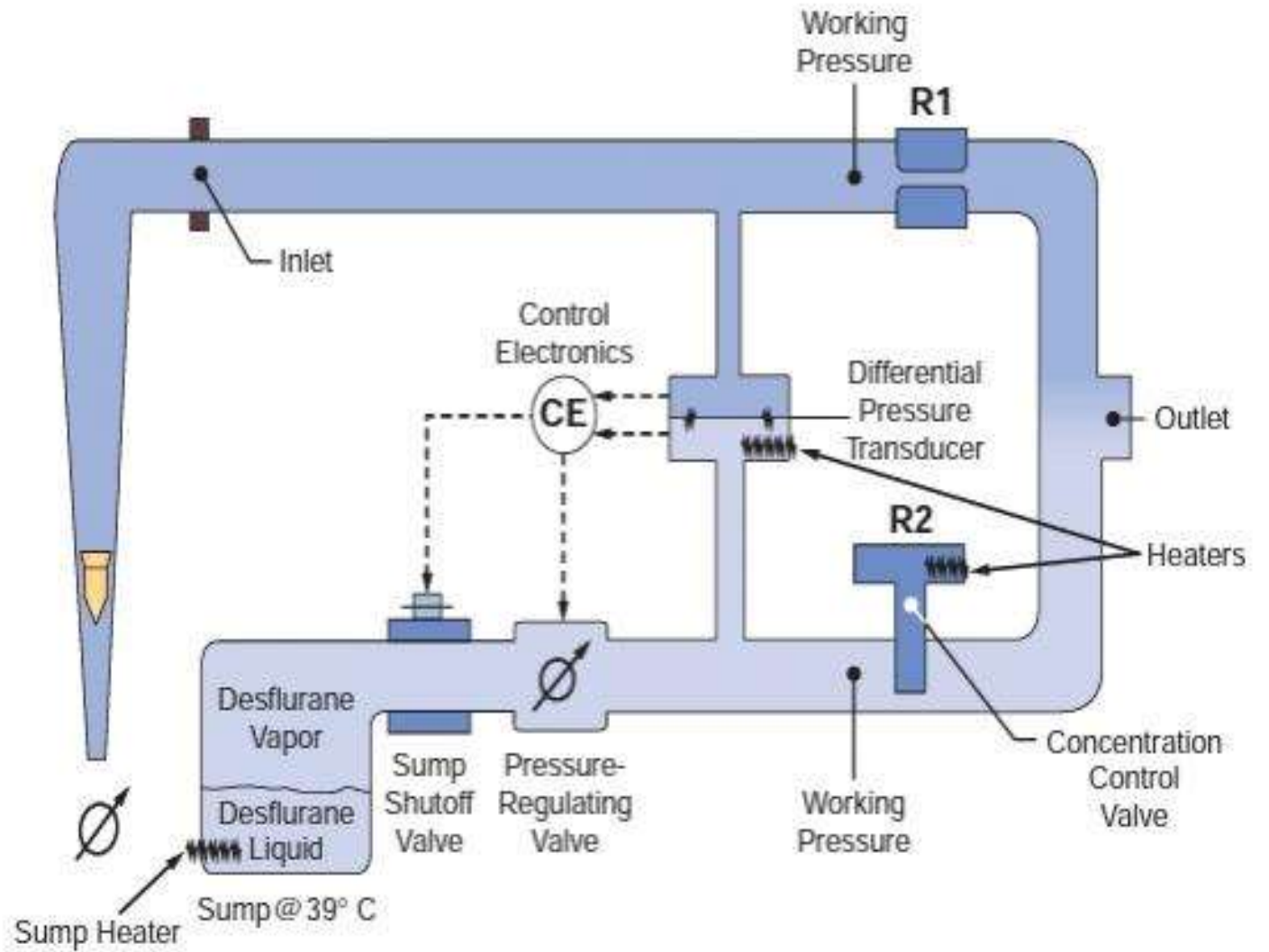


FIGURE 15.8 ■ Tec 6 desflurane vaporizer.

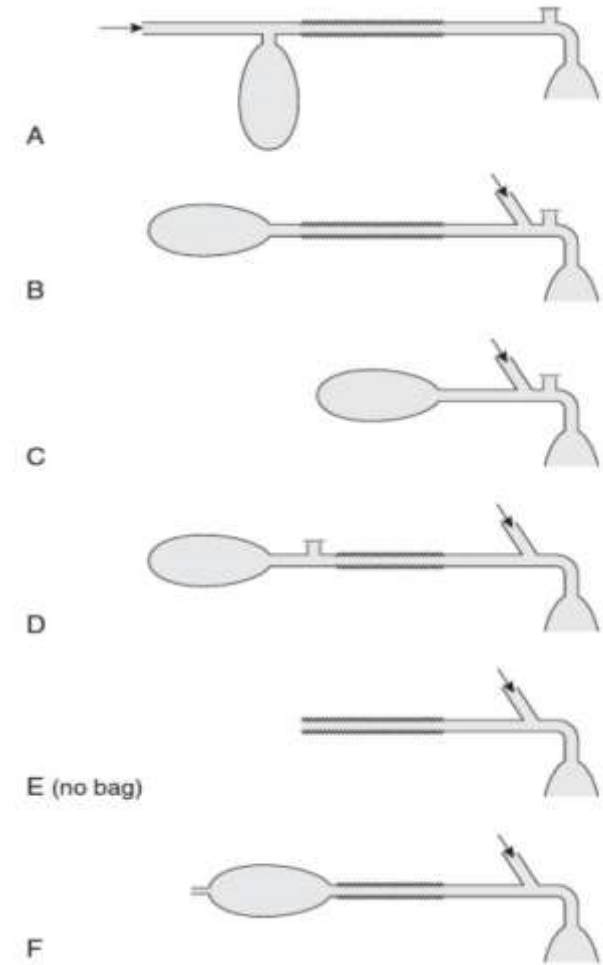


# ANESTHESIA BREATHING CIRCUITS

- The delivery system which conducts anaesthetic gases from the machine to the patient is termed colloquially a 'circuit' but is described more accurately as a breathing system. Terms such as 'open circuits', 'semi-open circuits' or 'semi-closed circuits' should be avoided. The 'closed circuit' or circle system is the only true circuit, as anaesthetic gases are recycled.
- Breathing circuits :
  - Mapilson breathing system
  - Circle system

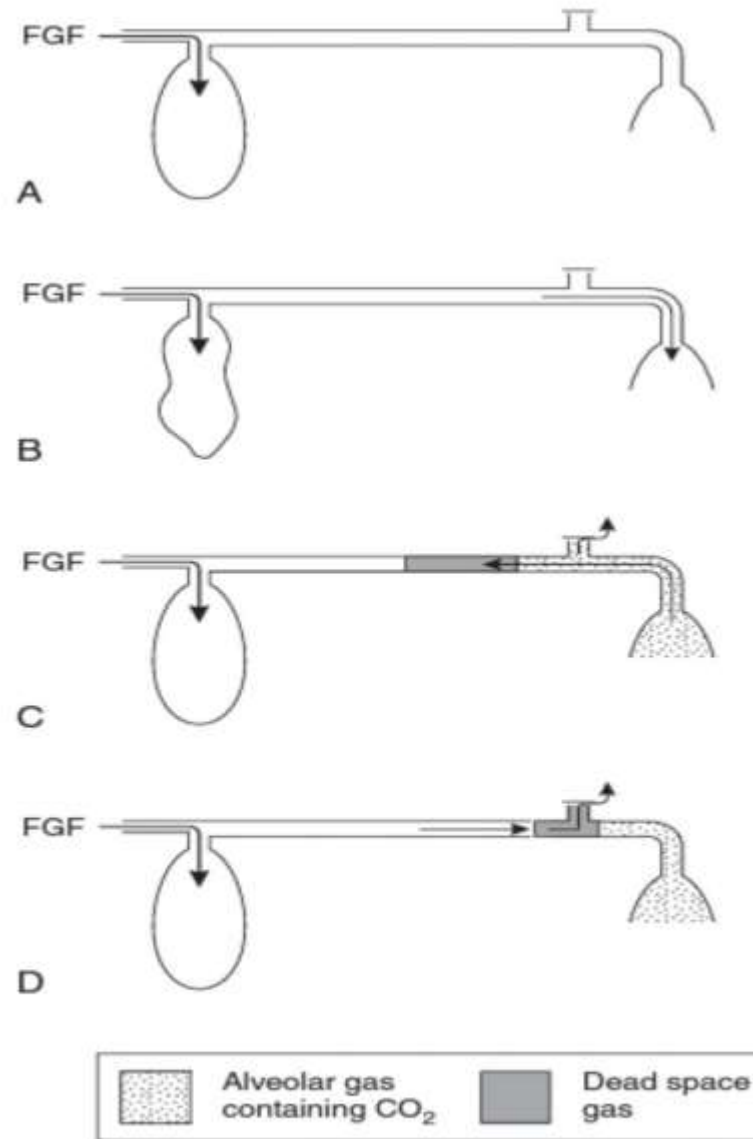
# COMPONENTS AND CLASSIFICATION OF MAPLESON BREATHING SYSTEMS

- Components : (breathing tube, fresh gas inlet, adjustable pressure-limiting [APL] valve, and reservoir bag)
- In 1954, Mapleson classified anaesthetic breathing systems into five types , the Mapleson E system was modified subsequently by Rees, but is classified as the Mapleson F system. The systems differ considerably in their 'efficiency', which is measured in terms of the fresh gas flow (FGF) rate required to prevent rebreathing of alveolar gas during ventilation



# MAPLESON (A) SYSTEMS

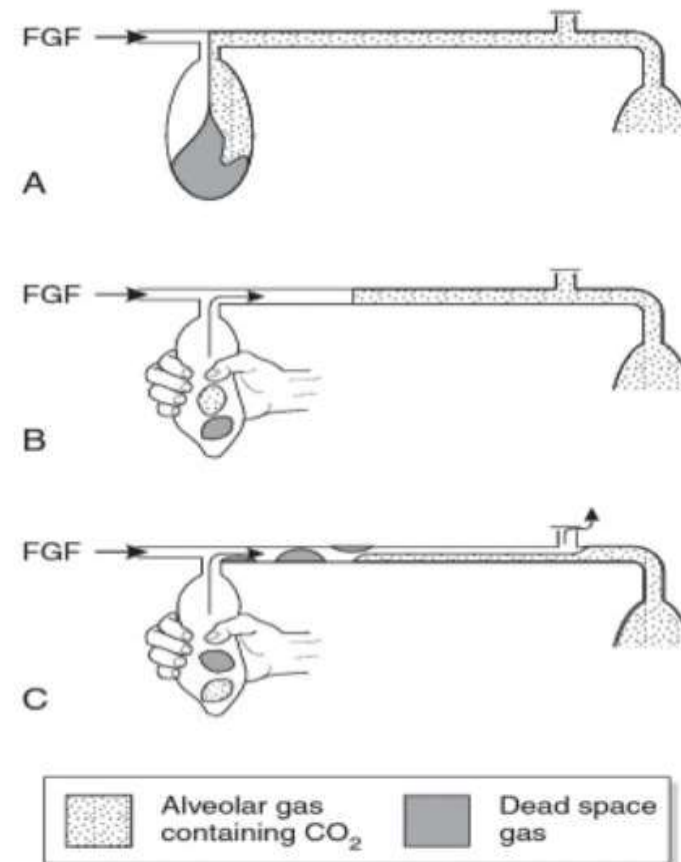
- The most commonly used version is the Magill attachment. The corrugated hose should be of adequate length (usually approximately 110 cm). It is the most efficient system during spontaneous ventilation, but one of the least efficient when ventilation is controlled. During spontaneous ventilation, there are three phases in the ventilatory cycle: inspiratory, expiratory and the expiratory pause.



**FIGURE 15.14** ■ Mode of action of Magill attachment during spontaneous ventilation. See text for details. FGF, fresh gas flow.

## MAPLESON (A) SYSTEMS

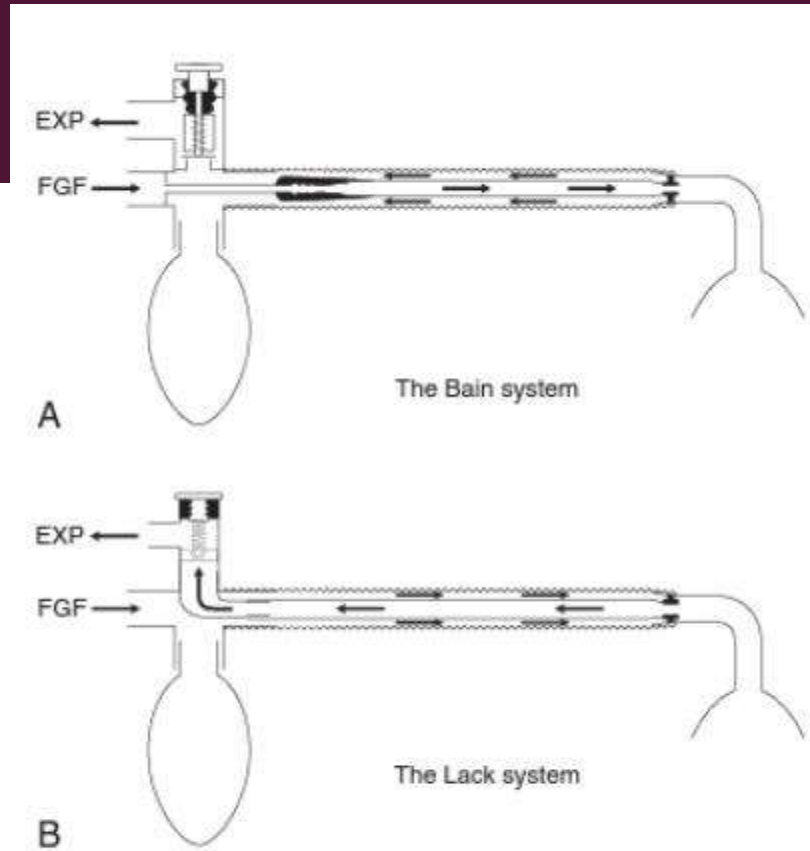
The major disadvantage of the Magill attachment during surgery is that the spill valve is attached close to the mask. This makes the system heavy, particularly when a scavenging system is used, and it is inconvenient if the valve is in this position during surgery of the head or neck.



**FIGURE 15.15** ■ Mode of action of Magill attachment during controlled ventilation. See text for details. FGF, fresh gas flow.

# THE LACK SYSTEM

- The Lack system is a modification of the Mapleson A system with a coaxial arrangement of tubing. This permits positioning of the spill valve at the proximal end of the system. The inner tube must be of sufficiently wide bore to allow the patient to exhale with minimal resistance. The Lack system is not quite as efficient as the Magill attachment.



**FIGURE 15.16** ■ Coaxial anaesthetic breathing systems. (A) Bain system (Mapleson D). (B) Lack system (Mapleson A). FGF, fresh gas flow; EXP, expired gas.

## MAPLESON B AND C SYSTEMS

- These systems cause mixing of alveolar and fresh gas during spontaneous or controlled ventilation. Very high FGF rates are required to prevent rebreathing.
- They are not used nowadays in anesthesia practice.



## MAPLESON D SYSTEM

- The Mapleson D arrangement is inefficient during spontaneous breathing .During expiration, exhaled gas and fresh gas mix in the corrugated tube and travel towards the reservoir bag .When the reservoir bag is full, the pressure in the system increases, the spill valve opens and a mixture of fresh and exhaled gas is vented; this includes the dead space gas, which reaches the reservoir bag first.
- Although fresh gas pushes alveolar gas towards the valve during the expiratory pause, a mixture of alveolar and fresh gases is inhaled from the corrugated tube unless the FGF rate is at least twice as great as the patient's minute volume, i.e. at least 12 L/ min in the adult.

## MAPILSON D AND BAIN COAXIAL SYSTEM

- In some patients, an FGF rate of  $250 \text{ mL kg}^{-1} \text{ min}^{-1}$  is required to prevent rebreathing. However, the Mapleson D system is more efficient than the Mapleson A during controlled ventilation, especially if an expiratory pause is incorporated into the ventilatory cycle.

The Bain coaxial system is the most commonly used version of the Mapleson D system. FGF is supplied through a narrow inner tube. This tube may become disconnected, resulting in hypoxaemia and hypercapnia. Before use, the system should be tested by occluding the distal end of the inner tube transiently with a finger or the plunger of a 2-mL syringe; there should be a reduction in the flow meter bobbin reading during occlusion and an audible release of pressure when occlusion is discontinued. Movement of the reservoir bag during anaesthesia does not necessarily indicate that fresh gas is being delivered to the patient.



## MAPLESON E SYSTEM

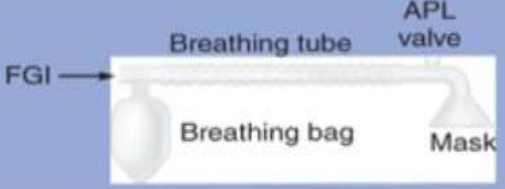



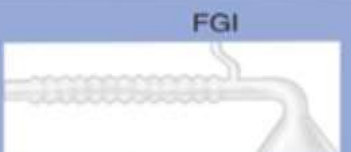

- The Mapleson E system, or Ayre's T-piece, has virtually no resistance to expiration and was used extensively in paediatric anaesthesia before the advantages of continuous positive airways pressure (CPAP) were recognized. It functions in a manner similar to the Mapleson D system in that the corrugated tube fills with a mixture of exhaled and fresh gas during expiration and with fresh gas during the expiratory pause. Rebreathing is prevented if the FGF rate is 2.5–3 times the patient's minute volume. If the volume of the corrugated tube is less than the patient's tidal volume, some air may be inhaled at the end of inspiration; consequently, an FGF rate of at least 4 L/min is recommended with a paediatric Mapleson E system. During spontaneous ventilation, there is no indication of the presence, or the adequacy of ventilation. It is possible to attach a visual indicator, such as a piece of tissue paper or a feather, at the end of the corrugated tube, but this is not very satisfactory.

# MAPELSON F SYSTEM

- The Mapleson F system, or Jackson Rees' modification of the Ayre's T-piece, includes an open-ended bag attached to the end of the corrugated tube. This confers several advantages:
  - It provides visual evidence of breathing during spontaneous ventilation.
  - By occluding the open end of the bag temporarily, it is possible to confirm that fresh gas is entering the system.
  - It provides a degree of CPAP during spontaneous ventilation and positive end-expiratory pressure (PEEP) during IPPV.
  - It provides a convenient method of assisting or controlling ventilation.
- The open end of the reservoir bag is occluded between the fourth and fifth fingers and the bag is squeezed between the thumb and index finger; the fourth and fifth fingers are relaxed during expiration to allow gas to escape from the bag. It is possible with experience to assess (approximately) the inflation pressure and to detect changes in lung and chest wall compliance. However, one main disadvantage of the Mapleson F system is that efficient scavenging is unsatisfactory and is non-standard.



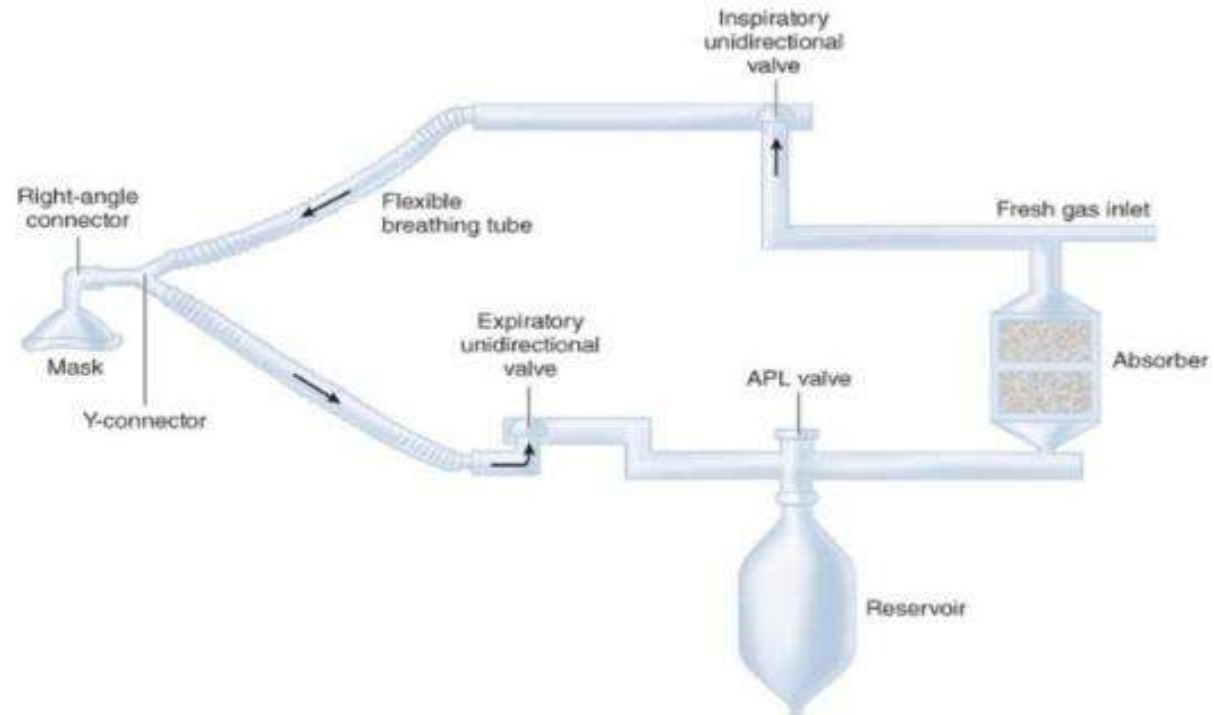
# MAPLESON CIRCUITS

Mapleson Class	Other Names	Configuration <sup>1</sup>	Required Fresh Gas Flows		Comments
			Spontaneous	Controlled	
A	Magill attachment		Equal to minute ventilation (~80 mL/kg/min)	Very high and difficult to predict	Poor choice during controlled ventilation. Enclosed Magill system is a modification that improves efficiency. Coaxial Mapleson A (Lack breathing system) provides waste gas scavenging.
B			2 × minute ventilation	2–2½ × minute ventilation	
C	Waters' to-and-fro		2 × minute ventilation	2–2½ × minute ventilation	
D	Bain circuit		2–3 × minute ventilation	1–2 × minute ventilation	Bain coaxial modification: fresh gas tube inside breathing tube.
E	Ayre's T-piece		2–3 × minute ventilation	3 × minute ventilation (I:E-1:2)	Exhalation tubing should provide a larger volume than tidal volume to prevent rebreathing. Scavenging is difficult.
F	Jackson-Rees' modification		2–3 × minute ventilation	2 × minute ventilation	A Mapleson E with a breathing bag connected to the end of the breathing tube to allow controlled ventilation and scavenging.

# CIRCLE SYSTEM

- The components of a circle system include:

- (1) a CO<sub>2</sub> absorber containing CO<sub>2</sub> absorbent
- (2) a fresh gas inlet
- (3) an inspiratory unidirectional valve and inspiratory breathing tube
- (4) a Y-connector
- (5) an expiratory unidirectional valve and expiratory breathing tube
- (6) an APL valve
- (7) a reservoir bag.





## CIRCLE SYSTEM

- This system has replaced the 'to-and-fro' system. The soda lime canister is mounted on the anaesthetic machine, and inspiratory and expiratory corrugated tubing conducts gas to and from the patient. The system incorporates a reservoir bag and spill valve and two low-resistance one-way valves to ensure unidirectional movement of gas. These valves are normally mounted in glass domes so that they may be observed to be functioning correctly. The spill valve may be mounted close to the patient or beside the absorber; during surgery to the head or neck, it is more convenient to use a valve near the absorber. Fresh gas enters the system between the absorber and the inspiratory tubing.

# ADJUSTABLE PRESSURE-LIMITING VALVE

- Most breathing systems incorporate an adjustable pressure-limiting valve (APL valve, spill valve, 'popoff' valve, expiratory valve), which is designed to vent gas when there is a positive pressure within the system. During spontaneous ventilation, the valve opens when the patient generates a positive pressure within the system during expiration; during positive pressure ventilation, the valve is adjusted to produce a controlled leak during the inspiratory phase.

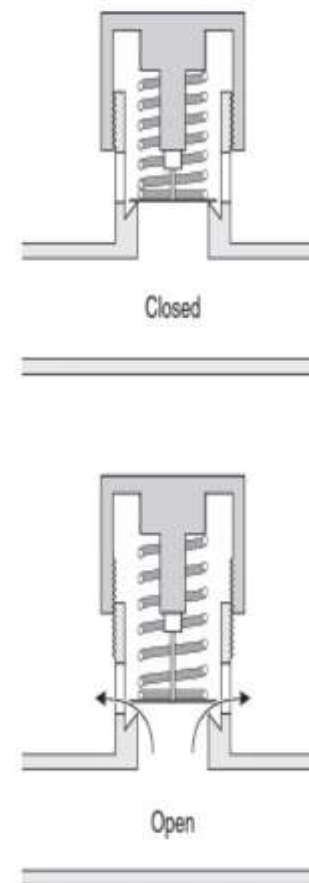


FIGURE 15.12 ■ Diagram of a spill valve. See text for details.

# CO<sub>2</sub> ABSORBENTS

- Different anesthesia breathing systems eliminate CO<sub>2</sub> with varying degrees of efficiency. The closed and semiclosed circle systems both require that CO<sub>2</sub> be absorbed from the exhaled gases to avoid hypercapnea.
- If one could design an ideal CO<sub>2</sub> absorbent, its characteristics would include lack of reactivity with common anesthetics, lack of toxicity, low resistance to gas flow, low cost, ease of handling, and efficiency in CO<sub>2</sub> absorption. The absorber canister. On many anesthesia machines, the absorber canister is composed of two clear plastic canisters arranged in series. The canisters can be filled either with loose bulk absorbent or with absorbent supplied by the factory in pre-filled plastic disposable cartridges called prepacks. Free granules from bulk absorbent can create a clinically significant leak if they lodge between the clear plastic canister and the O-ring gasket of the absorber, or between other joints in the circuit.
- Leaks have also been caused by defective prepacks, which were larger than factory specifications. Prepacks can also cause total obstruction of the circle system if the clear plastic shipping wrapper is not removed prior to use. Contemporary workstations from GE Healthcare and Dräger use proprietary CO<sub>2</sub> absorbent canisters that allow exchange of the canisters while maintaining the breathing circuit integrity.

# CO<sub>2</sub> ABSORBENTS

- **Chemistry of absorbents**  
:Several formulations of CO<sub>2</sub> absorbents are available today, including soda lime, and calcium hydroxide lime (Amsorb®). Of these agents, the most commonly used is soda lime.
- All serve to remove CO<sub>2</sub> from the breathing circuit with varying degrees of efficiency.



## **absorptive Capacity**

The maximum amount of CO<sub>2</sub> that can be absorbed by soda lime is 26 L of CO<sub>2</sub> per 100 g of absorbent. The absorptive capacity of calcium hydroxide lime is significantly less and has been reported at 10.2 L per 100 g of absorbent, also it does not produce compound A when sevoflurane is used. However, as previously mentioned, absorptive capacity is the product of both available chemical reactivity and physical (granule) availability.

## CO<sub>2</sub> ABSORBENTS: INDICATORS

- Ethyl violet is the pH indicator added to soda lime to help assess the functional integrity of the absorbent.
- This compound is a substituted triphenylmethane dye, Ethyl violet changes from colorless to violet in color when the pH of the absorbent decreases as a result of CO<sub>2</sub> absorption.
- Unfortunately, in some circumstances ethyl violet may not always be a reliable indicator of the functional status of absorbent. For example, prolonged exposure of ethyl violet to fluorescent lights can produce photodeactivation of this dye.

Although a diagnosis of depletion of CO<sub>2</sub> absorbent capability can be made by observation of clinical signs, the most sensitive indicator of this problem is capnography. If the end-expiratory level of exhaled CO<sub>2</sub> is increased, and the inspiratory level is greater than zero, then exhaustion of the CO<sub>2</sub> absorbent must be pursued as a possible cause.

The absorbent appears white even though it may have a reduced pH and its absorptive capacity has been exhausted. Even in the absence of color changes, clinical signs that the CO<sub>2</sub> absorbent is exhausted include

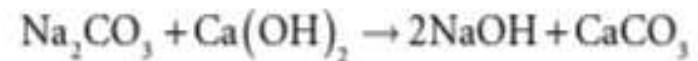
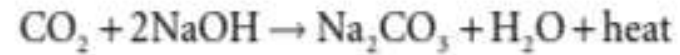
1. Increased spontaneous respiratory rate (requires that no neuromuscular blocking drug be used)
2. Initial increase in blood pressure and heart rate, followed later by a decrease in both
3. Increased sympathetic drive: skin lushing, sweating, tachydysrhythmia, hypermetabolic state (increased CO<sub>2</sub> production; must rule out malignant hyperthermia)
4. Respiratory acidosis as evidenced by arterial blood gas analysis
5. Increased surgical bleeding—due to both hypertension and coagulopathy





# SODA LIME

- Soda lime is the substance used most commonly for absorption of carbon dioxide in rebreathing systems.
- The major constituent is calcium hydroxide, but sodium and potassium hydroxides may also be present.
- Absorption of carbon dioxide occurs by the following chemical reactions:



Water is required for efficient absorption. There is some water in soda lime and more is added from the patient's expired gas and from the chemical reaction. The reaction generates heat and the temperature in the centre of a soda lime canister may exceed 60 °C.

# SODA LIME

Sevoflurane has been shown to interact with soda lime to produce substances that are toxic in animals. However, this does not appear to impose any significant risk in humans.

There is new evidence suggesting that the presence of strong alkalis such as sodium and potassium hydroxides could be the trigger of the interaction between volatile agents and soda lime. New carbon dioxide absorbers are now being manufactured without these hydroxides in order to reduce this interaction.

Ca(OH) <sub>2</sub>	94%
NaOH	5%
KOH	<1% or nil
Silica	0.2%
Moisture content	14-19%

# BARALYME

- Baralyme is another carbon dioxide absorber.
- It is a mixture of approximately 20% barium hydroxide and 80% calcium hydroxide.
- It may also contain some potassium hydroxide, an indicator and moisture.
- Barium hydroxide contains eight molecules of water of crystallization, which help to fuse the mixture so that it retains the granular structure under various conditions of heat and moisture. The granules of Baralyme are similar to those of soda lime.

## CIRCLE SYSTEM \_ ADVANTAGES AND DISADVANTAGES

- The major disadvantage of the circle system arises from its volume. If the system is filled with air initially, low flow rates of anaesthetic gases are diluted substantially and adequate concentrations cannot be achieved. Even if the system is primed with a mixture of anaesthetic gases, the initial rapid uptake by the patient results in a marked decrease in concentrations of anaesthetic agents in the system, resulting in light anaesthesia.
- Consequently, it is necessary usually to provide a total FGF rate of 3–4 L/ min to the system initially. This flow rate may be reduced subsequently, but it must be remembered that dilution of fresh gas continues at low flow rates and that rapid changes in depth of anaesthesia cannot be achieved.

# CIRCLE SYSTEM

## Disadvantages and Advantages of the Circle System

### *Disadvantages*

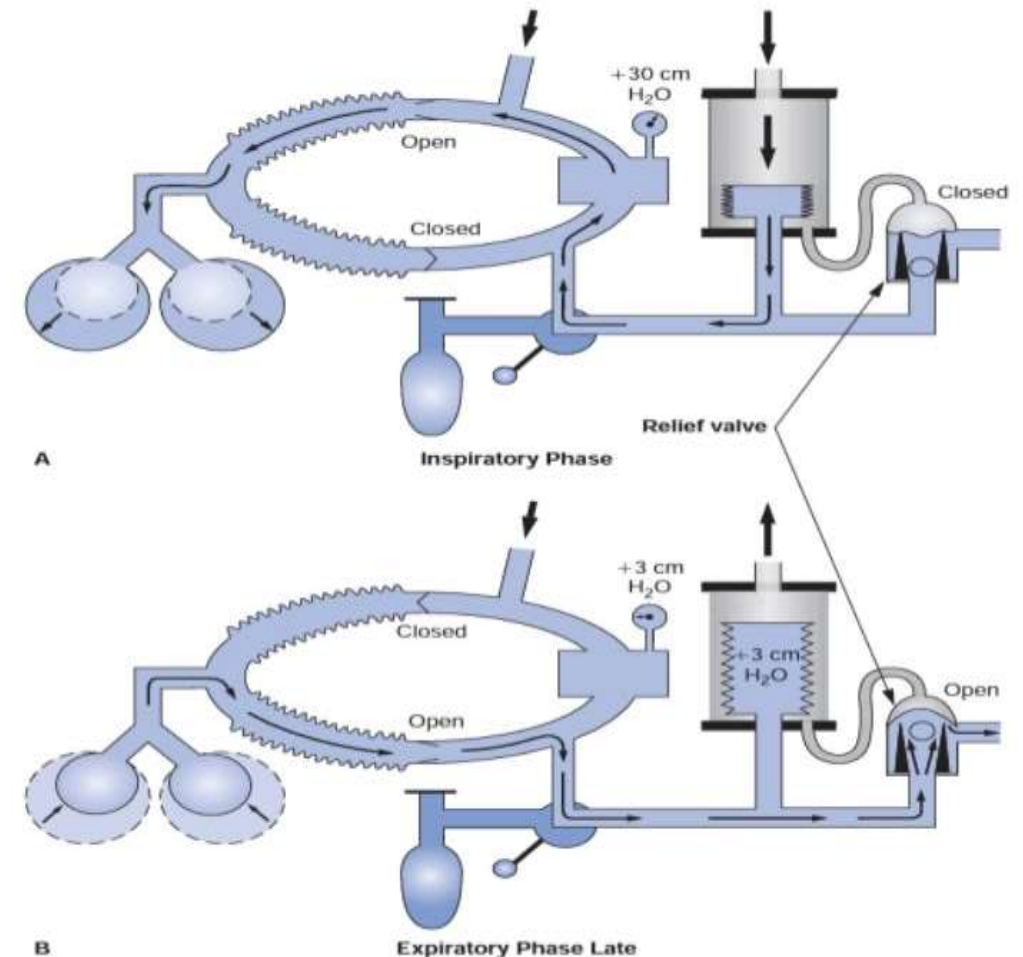
- Cumbersome equipment
- Risk of delivering hypoxic mixture
- Increased resistance to breathing
- Slow change in the depth of anaesthesia
- Risk of awareness
- Risk of a rise in end-tidal CO<sub>2</sub>
- Risk of unidirectional valves sticking
- Not ideal for paediatric patients breathing spontaneously
- Some inhalational agents may interact with soda lime

### *Advantages*

- Inspired gases are humidified and warmed
- Economical
- Minimal pollution

# CIRCLE SYSTEM : INSPIRATORY AND EXPIRATORY PHASES OF GAS FLOW

- Inspiratory (a) and expiratory (B) : phases of gas flow in a traditional circle system with an ascending bellows ventilator. The bellows physically separates the driving-gas circuit from the patient gas circuit. The driving-gas circuit is located outside the bellows, and the patient gas circuit is inside the bellows. During inspiratory phase (a), the driving gas enters the bellows chamber, causing the pressure within it to increase. This causes the ventilator relief valve to close, preventing anesthetic gas from escaping into the scavenging system, and the bellows to compress, delivering anesthetic gas within the bellows to the patient's lungs. During expiratory phase (B), pressure within the bellows chamber and the pilot line decreases to zero, causing the mushroom portion of the ventilator relief valve to open. Gas exhaled by the patient refills the bellows before any scavenging occurs, because a weighted ball is incorporated into the base of the ventilator relief valve. Scavenging occurs only during the expiratory phase, because the ventilator relief valve is only open during expiration. (Reprinted with permission from: Andrews JJ. The Circle System.



# MANUAL RESUSCITATION BREATHING SYSTEMS

- Occasionally, a patient may require emergency ventilation support using a source which does not rely on pressurized gas or electricity. It is recommended that such a breathing system is readily available in all areas where anaesthetics are administered in case such an emergency arises.

There are many different types of manual resuscitation breathing systems but fundamentally they all have the following components:

- a self-inflating bag
- a non-rebreathing valve
- a fresh gas input with or without an oxygen reservoir bag.



FIGURE 15.29 ■ The Laerdal manual resuscitation breathing system.



# MANUAL RESUSCITATION BREATHING SYSTEMS

- The self-inflating bag has a volume of approximately 1500 mL, 500 mL and 250 mL for the adult, child and infant sizes, respectively. The non-rebreathing valve has several components which ensure that, during the inspiratory phase, gas flows out of the bag into the patient and, during the expiratory phase, the valve ensures that exhaled gas escapes through the expiratory port without mixing with fresh gas. Three types of non-rebreathing systems are available, the Ruben, Ambu and Laerdal systems.
- Functionally, they are very similar but with some minor differences. The Ruben valve has a spring-loaded bobbin within the valve housing. The Ambu system has several series of valves which have either a single valve or double leaf valves to control unidirectional flow. The Laerdal system has three components: a duck-billed inspiratory/expiratory valve, a valve body housing inspiratory and expiratory ports and a non-return flap valve in the expiratory port.

# VENTILATORS

- Mechanical ventilation of the lung may be achieved by several mechanisms, including the generation of a negative pressure around the whole of the patient's body except the head and neck (cabinet ventilator or 'iron lung'), a negative pressure over the thorax and abdomen (cuirass ventilators) or a positive pressure over the thorax and abdomen (inflatable cuirass ventilators).
- However, during anaesthesia, and in the majority of patients who require mechanical ventilation in the intensive care unit, ventilation is achieved by the application of positive pressure to the lungs through a laryngeal mask airway, tracheal tube or tracheostomy tube.

## VENTILATORS :BELLOWS CLASSIFICATION .

- The direction of bellows movement during the expiratory phase determines the bellows classification.
- Ascending (standing) bellows ascend during the expiratory phase, whereas descending (hanging) bellows descend during the expiratory phase.
- Older pneumatic ventilators and some new anesthesia workstations use weighted descending bellows, while most contemporary electronic ventilators have an ascending bellows design. Of the two configurations, the ascending bellows is generally thought to be safer.
- An ascending bellows will not fill if a total disconnection occurs. However, the bellows of a descending bellows ventilator will continue its upward and downward movement despite a patient disconnection.
- The driving gas pushes the bellows upward during the inspiratory phase. During the expiratory phase, room air is entrained into the breathing system at the site of the disconnection because gravity acts on the weighted bellows. The disconnection pressure monitor and the volume monitor may be fooled even if a disconnection is complete. Some contemporary anesthesia workstation designs have returned to the descending bellows to integrate fresh gas decoupling (Dräger Julian and Datascope Anestar). An essential safety feature on any anesthesia workstation that utilizes a descending bellows is an integrated CO<sub>2</sub> apnea alarm that cannot be disabled while the ventilator is in use.

# LOW FRESH GAS FLOW DURING MECHANICAL VENTILATION

- It is important to understand that on most older anesthesia workstations, gas flow from the anesthesia machine into the breathing circuit is continuous and independent of ventilator activity. During the inspiratory phase of mechanical ventilation, the ventilator relief valve is closed, and the breathing system's APL (pop-off) valve is out of circuit. Therefore, the patient's lungs receive the volume from the bellows plus that entering the circuit from the flowmeters during the inspiratory phase. Factors that influence the relationship between set tidal volume and exhaled tidal volume include the FGF settings, the inspiratory time, the compliance of the breathing circuit, external leakage, and the location of the tidal volume sensor. Usually, the volume gained from the flowmeters during inspiration is counteracted by the volume lost to compliance of the breathing circuit, and set tidal volume generally approximates the exhaled tidal volume. However, certain conditions such as inappropriate activation of the oxygen flush valve during the inspiratory phase can result in barotrauma and/or volutrauma to the patient's lungs because excess pressure and volume may not be able to be vented from the circle system.

## VENTILATORS: POWER SOURCE

The power source required to operate a mechanical ventilator is provided by compressed gas, electricity, or both. Older pneumatic ventilators required only a pneumatic power source to function properly. Contemporary electronic ventilators from Dräger Medical, Datex-Ohmeda, and others require either an electrical only or both an electrical and a pneumatic power source.

# SCAVENGING SYSTEM

The principal sources of pollution by anaesthetic gases and vapours include:

- discharge of anaesthetic gases from ventilators
- expired gas vented from the spill valve of anaesthetic breathing systems
- leaks from equipment, e.g. from an ill-fitting face mask
- gas exhaled by the patient after anaesthesia. This may occur in the operating theatre, corridors and recovery room
- spillage during filling of vaporizers.

# SCAVENGING SYSTEM

- most attention has centred on removing gas from the expiratory ports of breathing systems and ventilators, other methods of reducing pollution should also be considered:
- Reduced use of anaesthetic gases and vapours. The use of the circle system reduces the potential for atmospheric pollution.
- The use of inhalational anaesthetics may be obviated totally by using total intravenous anaesthesia or local anaesthetic techniques.
- Air conditioning: Air conditioning units which produce a rapid change of air in the operating theatre reduce pollution substantially. However, some systems recycle air, and older operating theatres, dental surgeries and obstetric delivery suites may not be equipped with air conditioning.
- Care in filling vaporizers. Great care should be taken not to spill volatile anaesthetic agent when a vaporizer is filled. The use of agent-specific connections reduces the risk of spillage.



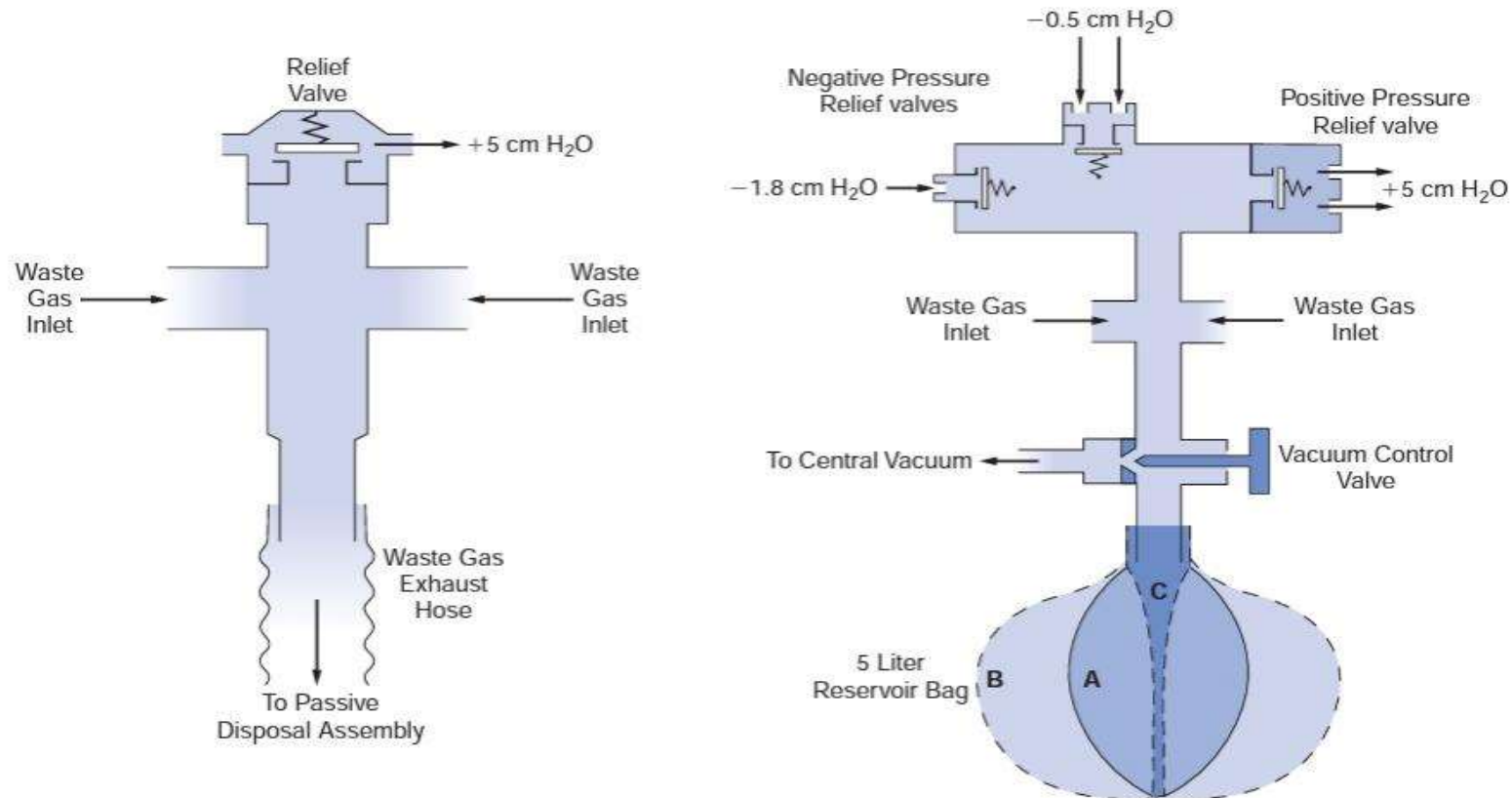
# SCAVENGING APPARATUS

- Anaesthetic gases vented from the breathing system are removed by a collecting system. A variety of purpose-built scavenging spill valves is available.
- Waste gases from ventilators are collected by attaching the scavenging system to the expiratory port of the ventilator.
- Connectors on scavenging systems have a diameter of 30 mm to ensure that inappropriate connections with anaesthetic apparatus cannot be made.

# SCAVENGING SYSTEM

- Disposal systems may be active, semi-active or passive.
- **Active Systems** : These employ apparatus to generate a negative pressure within the scavenging system to propel waste gases to the outside atmosphere. The system may be powered by a vacuum pump or a Venturi system. The exhaust should be capable of accommodating 75 L/ min continuous flow with a peak of 130 L/ min. Usually, a reservoir system is used to permit high peak flow rates to be accommodated. In addition, there must be a pressure-limiting device within the system to prevent the application of negative pressure to the patient's lungs.
- **Semi-Active Systems** :The waste gases may be conducted to the extraction side of the air-conditioning system, which generates a small negative pressure within the scavenging tubing. These systems have variable performance and efficiency.
- **Passive Systems**: These systems vent the expired gas to the outside atmosphere. Gas movement is generated by the patient. Consequently the total length of tubing must not be excessive or resistance to expiration is high. The pressure within the system may be altered by wind conditions at the external terminal; on occasions, these may generate a negative pressure, but may also generate high positive pressures. Each scavenging location should have a separate external

# SCAVENGING SYSTEM



**FIGURE 24-41.** Closed scavenging interfaces. **(Left)** Interface used with a passive disposal system. **(Right)** Interface used with an active system. See text for details. (Modified with permission from: **(Left)** *Scavenger Interface for Air Conditioning: Instruction Manual*. Telford, PA: North American Dräger; 1984. **(Right)** *Narkomed 2A Anesthesia System: Technical Service Manual*. Telford, PA: North American Dräger; 1985.)



- Thank you