



# MEDICAL GENETICS TEST BANK

DOCTOR 2020

Collected by:

Laith Sami

Shahed Atiyat

## **MEDICINE PAST PAPER**

**1-The number of human chromosomes by the end of anaphase of meiosis II is:**

- a. 69
- b. 23
- c. 46
- d. 115
- e. 92

Answer: C

**2-Imagine if the humans' diploid chromosomal complement is 10 instead of 46.**

**What would the number of possible combinations of meiosis be:**

- a. 64
- b. 32
- c. 16
- d. 4
- e. 8

Answer :B

**3-This chromosome is:**

- a. Metacentric
- b. Acrocentric
- c. Submetacentric
- d. Interphase chromosome
- e. Telocentric



Answer : C

**4-Which P arm of the following chromosomes carries rDNA genes?**

- a. 3
- b. 15
- c. 6
- d. 12
- e. 9

Answer : B

**5-The karyotype where euchromatic regions stain more darkly and the light regions are heterochromatin is:**

- a. Q-banding
- b. C-banding
- c. G-banding
- d. T-banding
- e. R-banding

Answer : E

**6- Which of the following fetal tissues are used for studying the fetal chromosomes :**

- a. Lymphocytes
- b. Check swap
- c. Amniotic fluid
- d. Skin biopsy
- e. Bone marrow

Answer : C

**7-How many double stranded DNA molecules are in a somatic human cell that is in present G2 phase:**

- a. 46
- b. 23
- c. 92
- d. There are no double stranded DNA molecules in G2
- e. 69

Answer : C

**8-The practical way to visualize a karyotype of a suspected very large chromosomal deletion, is to:**

- a. Arrest the cells at anaphase
- b. Arrest the cells at metaphase
- c. Arrest the cells at S phase
- d. Arrest the cells at telophase
- e. Arrest the cells at prometaphase

Answer :B

**9-All of the following regarding telomeres is true EXCEPT :**

- a. Telomeres consist of a repeated sequence of TTAGGG
- b. Telomeres are shortened by each cycle of DNA replication
- c. It codes for important genes .
- d. Prevents end-to-end fusion of chromosomes
- e. Cancer cells are characterized by high telomerase activity

Answer : C

**10-One of the following is true about telomerase :**

- a. inactivation of telomerase contributes for the extended lifespan of cancer cells .
- b. it uses DNA template
- c. it extends the daughter DNA strand to become longer than the parental DNA
- d. whole telomere has the same sequence
- e. activity of telomerase increases with age

Answer : D

**11-A cell is in G0 phase. How many chromosomes does it have ?**

- a. 46
- b. 23
- c. 92

Answer : A

**12-What is the karyotype shown in the?**

figure ?

- a. 46 XX
- b. 47 XY
- c. 46 XY

Answer : C

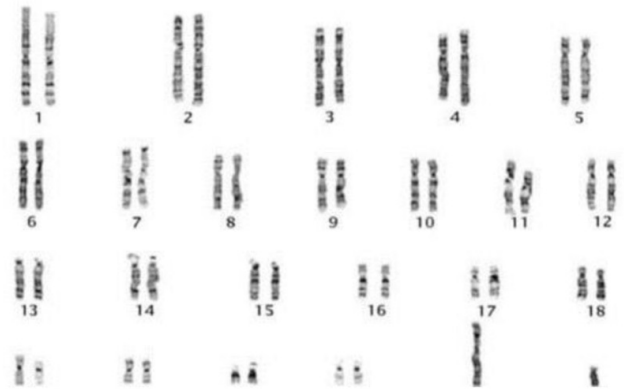

**13-The most commonly used stain for metaphase chromosomes is \_\_\_\_\_?**

- a. Quinacrine stain
- b. Giemsa stain
- c. Trypsin

Answer : B

**14-The study of chromosomes and cell division is called :**

- a. Cytogenetics
- b. Cytology
- c. Pedigree

Answer : A

**15-The figure depicts two possible graphs of an assumed population genetic diversity. In comparison to each other:**

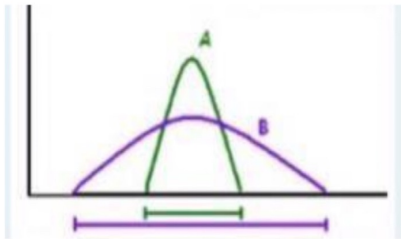

- a. Crossing over occurs during mitosis not meiosis. Therefore, the population genetic diversity is irrelevant and graphs A and B are equally possible to occur whether crossing over happens or not
- b. The crossing over does not influence the genetic diversity of the population, therefore the graphs A and B are equally possible to occur regardless whether crossing over occurs or not
- c. If crossing over does not occur at all during meiosis, the population will favor graph B
- d. If crossing over does occur during meiosis, the population will favor graph B
- e. If crossing over does occur during meiosis, the population will favor graph A.

Answer :D

**16- Which one of the following pairs is mismatched ?**

- a. Patau syndrome: 47,XX,+13
- b. Edward syndrome: 47, XX, +18
- c. Down Syndrome: 47, XX, +18

Answer : C

**17- A female with a flattened face, small head, short neck, protruding tongue, small ears, and a poor muscle tone (hypotonia). She probably has a genetic disorder that's caused by \_\_\_\_\_?**

- a. Trisomy 21
- b. Monosomy X
- c. Trisomy X

Answer : A

**18- Which of the following genetic changes is associated with a female whose karyotype is 46,XY ?**

- a. SRY gene mutations (deletions, translocations, ...etc).
- b. Monosomy X
- c. Triple X syndrome

Answer : A

**19- Chronic myeloid leukemia is caused by \_\_\_\_\_?**

- a. t(9;22); a translocation that fuses part of the ABL1 gene from chromosome 9 with part of the BCR gene from chromosome 22, creating a gene called BCRABL1.
- b. Having 3 copies of chromosome number 18.
- c. Trisomy 13.

Answer : A

**20- The most common aneuploidy that infants can survive with is \_\_\_\_\_ (most compatible with life)?**

- a. Trisomy 18 (Edwards syndrome)
- b. Monosomy X (Turner syndrome)
- c. Trisomy 21 (Down syndrome)

Answer : C

**21-The most stable chromosome of the following is :**

- a. 46 ,OY
- b. 47 , XY – trisomy 14
- c. 45, XY, t (14,21 )

Answer : C

**22- A patient with klinefelter syndrome can be seen as :**

- a. A male with 47 XXY
- b. A female with 47 XXY
- c. A female with 45 OX

Answer : A

**23-Which of the following human triploid is possible to be found in adults :**

- a. 92, XXXY
- b. Triploid cannot be found in adult human because it is incompatible with life
- c. 23, XY
- d. 92, YY
- e. 69, XXY

Answer : B



**24-Trisomy 47,XYY is a syndrome with signs and symptoms that range from being barely noticeable to learning disabilities, speech delay, low muscle tone. How would you expect this syndrome to have occurred?**

- a. Dispremy
- b. Endomitosis
- c. Fertilization by two sperms
- d. Chromosomal rescue
- e. Nondisjunction of paternal gametes

Answer : E

**25-Which of the following karyotype is expected to be associated with abnormal phenotype [Note: "t" is translocation, and "del" is deletion]:**

- a. Deletion of the "P" arm of chromosome 5. Karyotype is 46,XX,del5p
- b. Balanced double Robertsonian translocation between both chromosomes 13 and both chromosomes 14. Karyotype is 44,XX,t(13q;14q) \*2.
- c. Deletion of the "P" arm of chromosome 22. Karyotype is 46,XX,de22p
- d. Balanced Robertsonian translocation between one chromosomes 13 and one chromosome 14. Karyotype is 45,XX,t(13q;14q)
- e. 46,XY

Answer : A

**26-What is the possibility for a couple to have a child with Edwards syndrome if the fathers' homologous chromosomes 18 fail to disjoin during meiosis 1?**

- a. 25%
- b. 0%
- c. 50%
- d. 100%
- e. 75%

Answer : C

**27-46 XX male syndrome is a rare condition, described by De la Chapelle et al. in 1964 where the individual has phenotypically male characteristics. It occurs in one out of every 20,000-25,000 newborn males. This condition could be related to:**

- a. Turner syndrome
- b. Translocation of acrocentric chromosomes
- c. SRY gene
- d. Rb gene
- e. Klinefelter syndrome

Answer : C

**28-If one of the parent who carries balanced reciprocal translocation mates with a partner with normal karyotype. What is the risk of having a fetus with abnormal chromosomal complement ?**

- a. 1/5
- b. 1
- c. 1/3
- d. 1/2
- e. 1/4

Answer : D

**29-A child person with clinical features that include: cardiovascular, brain with neurological, renal, gastrointestinal, respiratory, and skeletal malformations, craniofacial abnormalities such as prominent occiput, hand and feet anomalies including clenched hand. This patient is most probably affected with:**

- a. Trisomy 18
- b. Trisomy 21
- c. Turner Syndrome

- d. Partial Trisomy 21
- e. Klinefelter Syndrome

Answer : A

**30-In the routinely performed karyotype (G-banding). Which of the following would you expect to have more clinical impact and lead to a disease ?**

- a. A duplication of a region with a light band
- b. A duplication of a region with a light band
- c. No clinical consequences will be observed due to a single band chromosomal aberration
- d. A deletion of a region with a light band
- e. A deletion of a region with a dark band

Answer : D

**31-A person whose karyotype is 45,XX,t(15q;21q). If she mates with a 46, XY normal individual. What is the possibility that they will have a zygote which will develop into Down syndrome? ("t" is translocation):**

- a. 1/6
- b. 1/4
- c. 1
- d. 1/2
- e. 1/3

Answer : A

**32- 47 XYY occurs due to :**

- a. chimeric event
- b. nondisjunction event from both parents
- c. paternal nondisjunction
- d. uniparental disomy (UPD)
- e. maternal nondisjunction

Answer : C

**33-If an embryo with 46 chromosomes develops from an egg that lost its nucleus,**

it will most probably become :

- a. Partial mole
- b. Complete mole
- c. Normal conception
- d. The fertilized egg will die before dividing
- e. Fetus that lacks placenta

ANSWER : B

**34-Which one of the following karyotypes is most likely to be found in normal human ovarian progenitor cell ?**

- a. 22, Y
- b. 46, XY
- c. 46, XX
- d. 23, X
- e. None of the above

ANSWER: C

**35-A chromosomal analysis is obtained on a young woman with mild signs of Patau syndrome and reveals a 46,XX/47,XX +13 mosaic karyotype. Nondisjunction is most likely to have occurred in:**

- a. Mosaic Patau are not possible to happen because they are incompatible with life
- b. mitosis after fertilization
- c. Parental meiosis II
- d. Parental meiosis I
- e. Parental progenitor cells S Phase

ANSWER : B

**36-When a pair of twins is conceived and one embryo dies in the womb. The surviving fetus may absorb some of the cells of its deceased twin. The surviving twin will be :**

- a. Tetraploid
- b. Triploid
- c. Mosaic
- d. Chimeric
- e. Partial trisomy

ANSWER : D

**37- 45,X/46,XX karyotype was revealed in the peripheral lymphocytes of a Turner syndrome patient. Which of the following is the underlying cause ?**

- a. Reciprocal translocation
- b. Nondisjunction in meiosis II
- c. Nondisjunction in mitosis
- d. Nondisjunction in meiosis I
- e. Robertsonian translocation

ANSWER : C

**38- How many Barr bodies in genotype (XX)?**

Ans:1

**39- For questions 2+3) If the mother is carrier for color blindness, while the father doesn't show the disease... answer questions 2+3: 2) :**

**40- what's the probability to have an affected male?**

Ans: 50%

**41- what's the probability to have an affected female?**

Ans: 0%

**42- chromosomal analysis of down syndrome:**

Ans: maternal meiosis 1

**43- least likely to live?**

Ans: 69, xxx

**44- number of chromosomes and chromatids at the end of meiosis 1?**

Ans: 23 chromosomes 46 chromatids

**45- what is the probability that a boy was inherited his Y chromosome from his mother's father?**

Ans: 0

**46- what is the predicted gender of an individual who has a karyotype of XXY?**

Ans: male

**47- the correct order of the phases of the cell cycle according to their period is:**

Ans: g1-->s-->g2-- pmat

**48- longest phase in the cell cycle**

Ans: interphase?

**49- responsible for recombination ?**

Ans: chiasma

**50- if a kind of animals have ( $2n = 6$ ), how many possible arrangements it can make?**

Ans:  $2^3 = 8$

**51- a long question talking about well grown fetus + large placenta, and asks about the possible mutation?**

Ans: diandry

**52- if a cell has 8 chromosomes, at the end of meiosis 1 what is the expected no. of chromosomes?**

Ans:4

**53) which chromosome carries rRNA genes on its p arm?**

Ans:15

**54) most probable choice of a sperm ?**

Ans: 23,x

**55) if you have a T-lymphocyte and you want to do a g banding for it, what is the correct sequence of the steps?**

Ans: phytohemagglutinin --> colcemid --> hypotonic --> fixative --> trypsin

**56) which of the following mutations will have two chromosomes at least?**

Ans: balanced translocation

**57) what is the mutation in (cri du chat)?**

Ans: deletion in 5p

**58) what is the mutation in CML?**

ANS : t(9,22)

**59) A woman with Robertsonian translocation between chr. 14 and 21 married from a normal man , which of the following will be a LIVE OFFSPRING?**

Ans: one copy of 14, two copies of 21, one Robertsonian chromosome

**60) ———-state that each homologous chromosome will separate and appear in a different daughter cell, such that each gamete receives one allele for a given trait., ———-states that chromosomes are aligned at the metaphase plate independently of each other**

Ans: Law of Segregation, Law of Independent Assortment

**61) which of the following is correct about G positive (dark )and G negative( light) areas?**

Ans: G negative areas have more genes than G positive areas

**62)A child with Polydactyly and Cleft lip has?**

Ans: trisomy 13

**63) which of the following has ovaries?**

Ans: XY with deletion in SRY

**64) The most common cause of triploidy is:**

Ans: Egg Fertilized by 2 sperms

**65) \*\*\*a woman with Robertsonian translocation has a karyotype of (46,xx,-14,-21,t(14q,21q) , married from a normal man 46,XY ,which one of the following has the LEAST probability to be a child of them?**

A-46 xx

B-47 xx +21

C-46 xy -14 (14q,21q)

D-46 xy -21 (14q,21q)

E-45,XY ?

Ans :B (We're not very sure)

**66) which chromosome the deletion of p arm will not have clinical appearance?**

Ans: 15

**67) Which of the following is the most probable live individual?**

Ans:47 xx+21

**68 -True statement:**

Answer: G negative (euchromatic region) is richer in genes than G positive (heterochromatic region)

**69- Large deletion in a chromosomal segment results:**

Answer: Prader-Willi syndrome



**70- A female with genotype (XXXX) has:**

Answer: 3 Barr bodies

**71-exchange of cells between these 2 different populations of embryonic cells:**

Answer: Chimera

# DENTISTRY PAST PAPER

**1. The chromatin in interphase \_\_\_\_\_ and in M phase \_\_\_\_\_:**

A- Condensed, Decondensed

B- Condensed, Condensed

C- Decondensed, Condensed

D- Decondensed, Decondensed

Ans : C

**2. The shortest satge in cell cycle:**

A- M

B- G0

C- G1

D- S

E- G2

Ans : A

**3. Chromosome 22 is:**

A- Acrocentric

B- Metacentric

C- Submetacentric

D- Telocentric

Ans : A

**4. Cells of the eye lense are:**

A- Haploid

B- Diploid

C- Triploid

D- Tetraploid

Ans : B

**5. If a GAMETE chromosomes are 16, what is the number of chromatids before anaphase 1?**

A- 8

B- 16

C- 32

D- 64

E- 128

Ans : D

**6. Pair homologous chromosomes in metaphase I, how many double strand DNA in it?**

A- 1 double strand DNA

B- 3 Double Strand DNA

C- 5 double strand DNA

D- 2 double strand DNA

E- 4 double strand DNA

Ans : E

**7. Recombination occurs in:**

A- Pachytene

B- Zygotene

C- Diplotene

D- Leptotene

E- Diakinesis

Ans : A

**8. Law of segregation related to \_\_\_\_\_ and law of independent assortment related to \_\_\_\_\_:**

A- Different chromosomes, homologous chromosomes

B- Homologous chromosomes, different chromosomes

Ans : B

**9. Which of the following cannot be used in karyotype?**

A- Chorionic villi biopsy

B- Lymphocyte

C- Bone Marrow

D- Erythrocyte

E- Skin biopsy

Ans : D

**10. Which banding technique stains heterochromatin (dark) and euchromatin (light)?**

A- T band

B- Q band

C- G band

D- R band

E- C band

Ans: C

**11. The location of beta satellite:**

A- p arm of Acrocentric chromosomes

B- q arm of Acrocentric chromosomes

C- p arm of Metacentric chromosomes

D- Centromere

E- Q arm of Metacentric chromosomes

Ans : A

**12. Which of the following has rDNA?**

A- 16

B- 15

C- 9

D- 5

Ans : B

**13. Which of the following deletion of the p arm causes abnormality?**

A- 13

B- 14

C- 15

D- 16

E- 21

Ans : D

**14. Which phase of the cycle is most likely to be interrupted for smaller abnormalities detection?**

A- Metaphase

B- Prometaphase

C- S phase

D- G phase

E- Anaphase

Ans : B

**15. The location of alpha satellite:**

A- p arm of Acrocentric chromosomes

B- Centromere

C- Telomere

D- Subtelomere

E- p arm of Metacentric chromosomes

Ans : B

**16. Protects the DNA and prevents end-to-end fusion:**

A- Telomere

B- Subtelomere

C- Centromere

Ans : A

**17. In which phase of gametogenesis nondisjunction will produce all the cells aneuploidy?**

A- G1 phase

B- S phase

C- MI

D- MII

E- G2 phase

Ans: C

**18. Which of the following cannot be seen in triploidy?**

A- 69 XXX

B- 69 XXY

C- 69 XYY

D- 69 YYY

Ans : D

**19. Which of the following results in net gain genetic material?**

- A- Deletion
- B- Duplication
- C- Reciprocal translocation
- D- Robertsonian translocation
- E- Inversion

Ans : B

**20. The most common cause of trisomy 21:**

- A- Maternal MII nondisjunction
- B- Maternal MI nondisjunction
- C- Paternal MII nondisjunction
- D- Paternal MI nondisjunction
- E- Mitosis

Ans : B

**21. SMOH gene located in psuedoautosomal in Y chromosome, do you expect that it will be located in 46 XX?**

- A- Yes, because it locates in psuedoautosomal region
- B- No, because we can't find Y chromosome genes on X chromosome
- C- No, SMOH is only found in males
- D- No, because sex chromosomes are hemizygous
- E- Yes, Y and X chromosomes have the same genes

Ans : A

**22. 46 XX male, the defect is related to:**

A- AZFa

B- SRY gene

Ans : B

**23. CML is caused by:**

A- Robertsonian translocation between 9 and 22

B- Deletion in 9

C- Reciprocal translocation between 9 and 22

Ans : C

**24. A healthy mother is married to a man who has a robertsonian 14,21 balance. What is the possibility to have a baby with down syndrome?**

A- 1/4

B- 1/2

C- 1

D- 2

E- 1/6

Ans : E

**25. Normal pregnancy results from:**

A- 1 maternal set of genes and 1 paternal set of genes

B- 1 maternal set of genes and 0 paternal set of genes

C- 0 maternal set of genes and 1 paternal set of genes

D- 2 maternal set of genes and 0 paternal set of genes

E- 0 maternal set of genes and 2 paternal set of genes

Ans : A



**26. Complete mole results from:**

- A- 1 maternal set of genes and 1 paternal set of genes
- B- 1 maternal set of genes and 2 paternal set of genes
- C- 2 maternal set of genes and 1 paternal set of genes
- D- 2 maternal set of genes and 0 paternal set of genes
- E- 0 maternal set of genes and 2 paternal set of genes

Ans : E

**27. Partial mole results from:**

- A- 1 maternal set of genes and 1 paternal set of genes
- B- 2 maternal set of genes and 0 paternal set of genes
- C- 2 maternal set of genes and 1 paternal set of genes
- D- 1 maternal set of genes and 0 paternal set of genes
- E- 0 maternal set of genes and 2 paternal set of genes

Ans : C

**28. Tetraploidy results from:**

- A- Haploid sperm and haploid egg
- B- Endomitosis after fertilization
- C- Diploid sperm and diploid egg
- D- Dispermy
- E- Nondisjunction in MI

Ans : B

**29. No fetus at all:**

- A- Complete molar
- B- Partial molar
- C- Triploidy

D- Normal pregnancy

E- Rubella infection with pregnancy

Ans : A

**30. Baby with macrocephaly and severe intrauterine growth retardation:**

A- Diandric

B- Digernic

Ans : B

**31. Baby with large placenta, with or without microcephaly:**

A- Diandric

B- Digernic

Ans : A

**32. 69 XYY occurs due to:**

A- Dispermic

B- Endomitosis

C- Tetraploidy

D- Nondisjunction MI

E- Nondisjunction MII

Ans : A

**33. Nondisjunction in miosisI happens between \_\_\_\_\_ and in miosisII**

**it happens between \_\_\_\_\_:**

A- Homologous chromosomes, non-sister chromatids

B- Homologous chromosomes, sister chromatids

C- Odd number of chromosomes, even number of chromosomes

D- Even number of chromosomes, odd number of chromosomes

Ans : B

**34. Normal phenotypically will be:**

A- 47, XXY

B- 45, X

C- 45, XX t(13:13)

D- 46, XY (t13:13)+13

E- 46, XYY

Ans : C

**35. Possibility of combinations for diploid cell with 10 chromosomes?**

A- 4

B- 8

C- 16

D- 32

E- 64

Ans : D

**36. Clinical features of Edward:**

Ans: 47 +18

**37. Clinical features of Patau:**

Ans: 47 +13

**38. Clinical features of klinefelter:**

Ans: 47, XXY

**39. Clinical features of turner:**

Ans: 45, X

**40. Clinical features of Cri Du Chat:**

Ans: Deletion in p arm of chromosome 5

**42)All of the following about Telomeres is correct except?**

It codes for important genes

**43)One of the following is true about Telomeres ?**

Whole Telomeres has the same sequence

**44)A cell in G0 phase,how many chromosomes?**

46

**45)Which of the following is mismatched?**

Down syndrome,xx,+13

**46)The most common aneuploidy that infants can survive with is \_ (most compatible with life);**

Trisomy 21 (down syndrome)

**47)The study of chromosomes and cell division is called:**

Cytogenetics

**48)Which of the following is incorrect regarding Angelman syndrome?**

It's caused by a micro deletion

## Lecture 6

**1. Which of the following statements is NOT associated with multifactorial disease inheritance?**

- A. Factors are usually both genetic and environmental.
- B. Increased incidence of siblings having the disease if a person has the disease late in life.
- C. Examples include multiple sclerosis, diabetes, and cancer.

Answer: B

**2. Pathogenic mutations in TBX5 cause Holt-Oram syndrome which includes cardiovascular (atrial septal defect, hypoplastic left heart syndrome), chest (Absent pectoralis major muscle) and skeletal anomalies (vertebral anomalies, triphalangeal thumb and carpal bone anomalies). The TBX5 phenotypic effect is related to which concept:**

- A. Reduced penetrance
- B. Sex limited.
- C. Pleiotropy
- D. Multifactorial
- E. Genetic heterogeneity

Answer: C

**3. The clinical features of patients with Marfan syndrome are caused by unusually stretchable connective tissue. The most observed features in Marfan syndrome affect the eye, the skeleton, and the cardiovascular system. This is an example of:**

- A. Allelic heterogeneity
- B. Pleiotropy
- C. Anticipation
- D. Penetrance
- E. Locus heterogeneity

Answer: B

**4. Genes affecting another gene phenotyping?**

Answer: Epistasis

**5. cystic fibrosis having more than one phenotypic effect, what is this called?**

Answer: Pleiotropy

**6. Which of the following statements is NOT associated with multifactorial disease inheritance?**

Answer: Increased incidence of the sibling having disease if a person has the disease late in life

---

## **Lecture 7**

**1. Expressivity can be described as:**

- A. One mutant gene can cause multiple phenotypic effects.
- B. The degree to which a gene is expressed depends on other genetic or environmental factors.
- C. All or none expression of a mutant gene.

Answer: B

**2. Which of the following fetal tissues are used for studying the fetal chromosomes?**

- A. Lymphocytes
- B. Check swap
- C. Amniotic fluid
- D. Skin biopsy
- E. Bone marrow

Answer: C

**3. Suppose there's an X-linked recessive disease, if the mother has the disease, while the father doesn't, what's the chance that they'll have an affected female?**

- A. 25%
- B. 50%
- C. 75%
- D. Zero

Answer: D

**4. Which of the following is true about Huntington disease?**

Answer: Autosomal dominant

**5. Which of the following is true about Marfan syndrome?**

Answer: Autosomal dominant

**6. Which of the following is true about Myotonic dystrophy?**

Answer: Autosomal dominant

**7. Which of the following is true about Albinism?**

Answer: Autosomal recessive

**8. Which of the following is true about Cystic fibrosis?**

Answer: Autosomal recessive

**9. A question talking about mild symptoms Vs. severe symptoms for the same disease?**

Answer: Variable expressivity

**10. You are asked to consult about a 2-month-old girl with hypotonia, seizures, and an elevated plasma lactate (8 mM/L, normal <2). Brain MRI shows a thin corpus callosum but no other abnormalities. You suspect pyruvate dehydrogenase deficiency. Which of the following is the most likely mode of inheritance in this infant?**

- A. X-linked
- B. Autosomal dominant
- C. Autosomal recessive
- D. Mitochondrial
- E. Sporadic

Answer: C

**11. The main treatment for PKU includes:**

- A. A lifetime diet with very limited intake of carbohydrate
- B. A lifetime diet with very limited intake of protein
- C. Neutral amino acid therapy

Answer: B

**12. Pedigree with different color degrees representing the severity of the disease between different members of the family?**

Answer: Expressivity

**13. A disease that differs in its presentation between females and males is:**

Answer: Sex influenced

**14. You are asked to consult about a 2-month-old girl with hypotonia, seizures, and an elevated plasma lactate (8 mM/L, normal deficiency. Which of the following is the most likely mode of inheritance in this infant?**

- A. X-linked
- B. Autosomal dominant
- C. Autosomal recessive
- D. Mitochondrial
- E. Sporadic

Answer: C

**15. Lisch nodules can be found in:**

Answer: neurofibromatosis type 1

---

## Lectures 8 + 9

**1. The following pedigree shows an:**

- A. Autosomal recessive disorder
- B. Autosomal dominant disorder
- C. X-linked recessive disorder

Answer: B

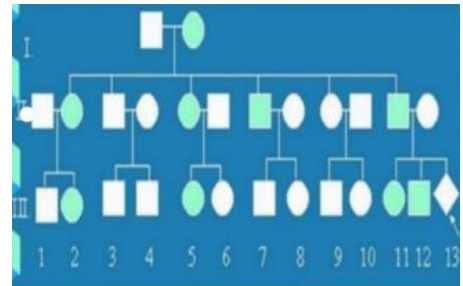

**2. What is the most probable mode of inheritance for this pedigree:**

- A. X- lined recessive
- B. Autosomal recessive
- C. Autosomal dominant
- D. Y- linked
- E. X- linked dominant

Answer: B

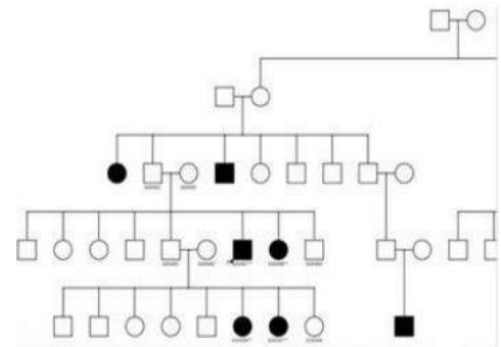



3. What is the most probable mode of inheritance for this pedigree:

- A. Y- linked
- B. X- linked dominant
- C. X- lined recessive
- D. Autosomal recessive
- E. Autosomal dominant

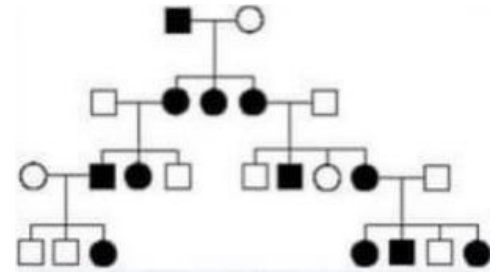

Answer: B

4. What is the most probable mode of inheritance for this pedigree?

- A. Autosomal dominant
- B. X- lined recessive
- C. Y- linked d. X- linked dominant
- D. Autosomal recessive

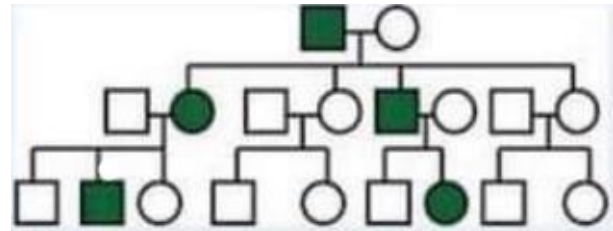

Answer: A

5. What is the most probable mode of inheritance for this pedigree:

- A. Autosomal dominant
- B. X- linked dominant
- C. Autosomal recessive
- D. X- lined recessive
- E. Y- linked

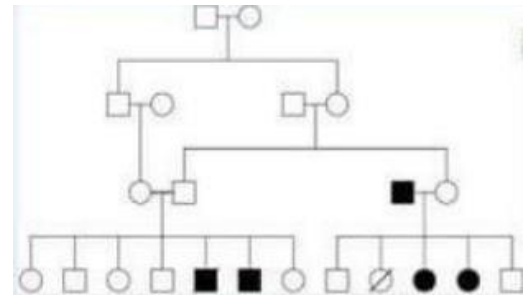

Answer: C

6. What is most probable mode of inheritance for this pedigree:

- A. Autosomal recessive
- B. X- lined recessive
- C. X- linked dominant
- D. Y- linked
- E. Autosomal dominant

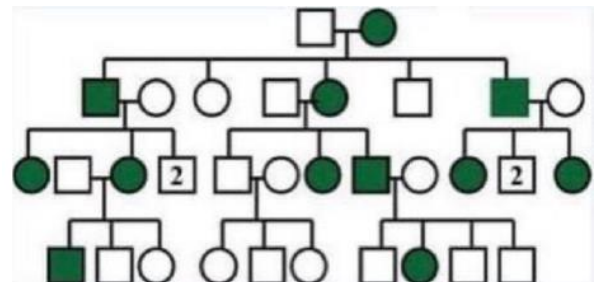

Answer: C



**10. What is the most probable mode of inheritance?**

- A. Autosomal Dominant
- B. X-Linked Recessive
- C. X-Linked Dominant
- D. Autosomal Recessive
- E. Y-Linked

Answer: B

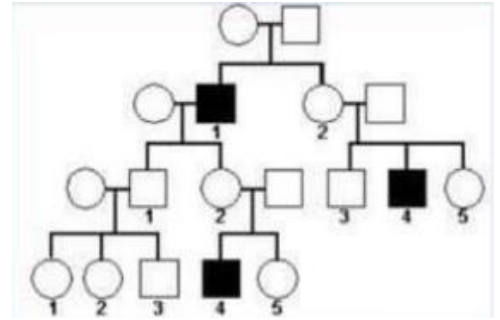

**11. What is the most probable mode of inheritance?**

- A. X-Linked Dominant
- B. Autosomal Recessive
- C. Y-Linked
- D. Autosomal Dominant
- E. X-Linked Recessive

Answer: E

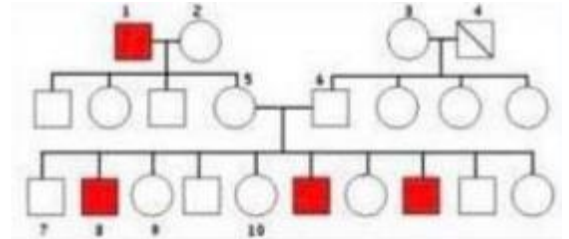

**12. What is the most probable mode of inheritance?**

- A. X-Linked Dominant
- B. Autosomal Recessive
- C. X-Linked Recessive
- D. Y-Linked
- E. Autosomal Dominant

Answer: E

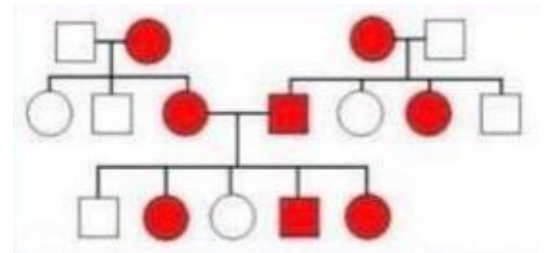

**13. What is the most probable mode of inheritance?**

- A. X-Linked Dominant
- B. Autosomal Dominant
- C. X-Linked Recessive
- D. Autosomal Recessive
- E. Y-Linked

Answer: E

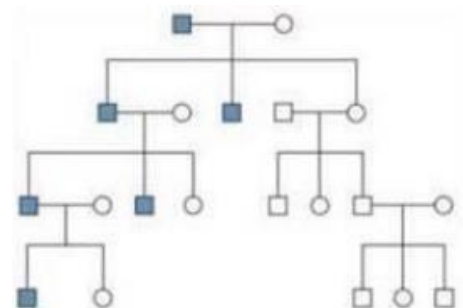

**14. What is the most probable mode of inheritance?**

- A. Autosomal Recessive
- B. Y-Linked
- C. Autosomal Dominant
- D. X-Linked Dominant
- E. X-Linked Recessive

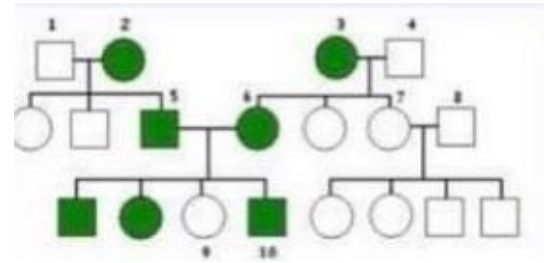

Answer: C

**15. What is the most probable mode of inheritance?**

- A. X-Linked Recessive
- B. Autosomal Recessive
- C. X-Linked Dominant
- D. Y-Linked
- E. Autosomal Dominant

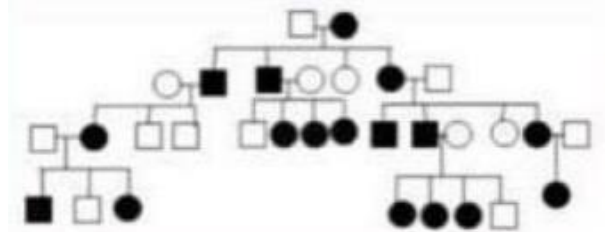

Answer: C

**16. Rob's father has a Huntington's disease and Rob himself doesn't want to know if he is affected or not. His wife has no history with the disease, and she is pregnant. What is the probability that the child is affected?**

Answer:  $\frac{1}{2}$

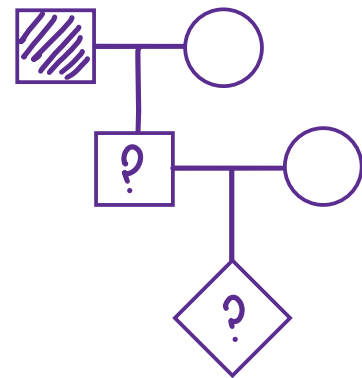

**17. Why X linked disease is less severe than autosomal diseases?**

Answer: Due to X inactivation

**18. True about X inactivation:**

Answer: Happens during embryonic development

**19. Vitamin D deficiency is:**

Answer: X - linked dominant

**20. Duchenne muscular dystrophy-DMD is:**

Answer: X - linked recessive

**21. Hemophilia is:**

Answer: X - linked recessive

**22. Color blindness is:**

Answer: X - linked recessive

**23. Pattern baldness, moustaches and beard in human males are examples of:**

**(Maybe not included)**

- A. Autosomal recessive traits
- B. Sex-influenced traits
- C. Sex-linked traits

Answer: B

**24. X-inactivation occurs during:**

Answer: Mitosis of female embryo

**25. What is the blood type for the unknown person?**

Answer: A

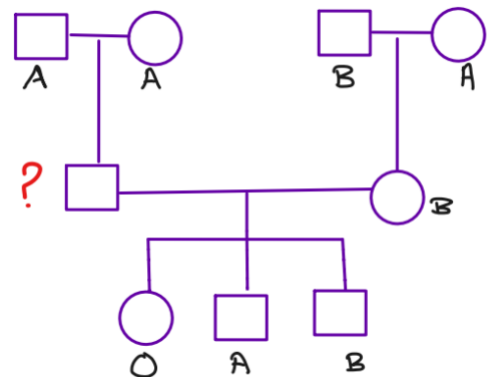

**25. True or false, in X chromosome inactivation, all X chromosome genes are inactivated?**

- A. True
- B. False

Answer: B

**26. Which is false regarding X-linked recessive disorders?**

- A. A carrier mothers produce all affected sons.
- B. Affected fathers produce no affected sons.
- C. Affected fathers produce no affected daughters.
- D. Affected mothers produce all affected sons.
- E. Carrier mothers produce no affected daughters.

Answer: A

**27. X- chromosome inactivation:**

- A. Normally takes place in males but not females
- B. Occurs in fruit flies but not in mammals
- C. Is the cause of Y chromosome being genetically inactive
- D. Takes place in humans so that same X chromosome is inactive in all of the cells of a female
- E. Result in genetically turning off one of the two X chromosomes in female mammals

Answer: D

**28. What is the most probable mode of inheritance in this pedigree?**

- A. X – linked recessive
- B. Autosomal recessive
- C. Autosomal dominant
- D. X- Linked dominant

Answer: B

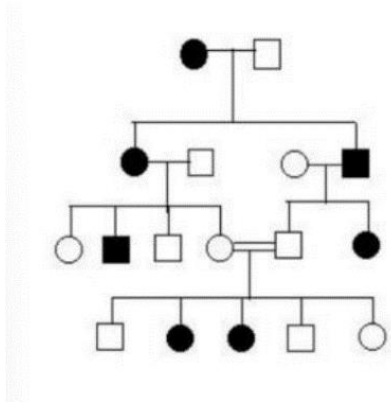

**29. What is the most probable mode of inheritance in this pedigree?**

- A. X- linked recessive
- B. Autosomal recessive
- C. Autosomal dominant
- D. X- Linked dominant

Answer: B

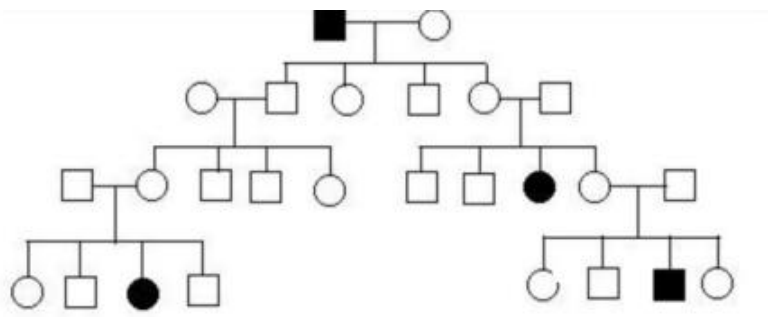

30. What is the most probable mode of inheritance in this pedigree?

- A. X- linked recessive
- B. Autosomal recessive
- C. Autosomal dominant
- D. X- Linked dominant

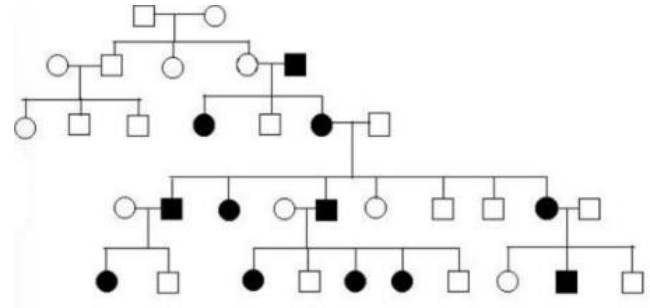

Answer: D

31. What is the most probable mode of inheritance in this pedigree?

- A. X- linked recessive
- B. Autosomal recessive
- C. Autosomal dominant
- D. X- Linked dominant

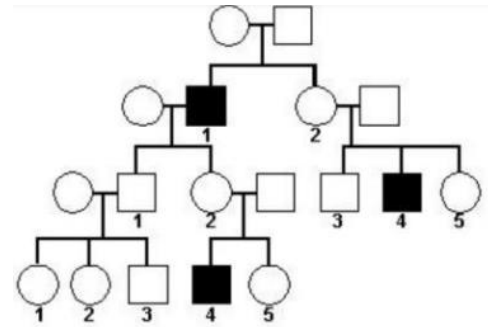

Answer: A

★ Further pedigrees here:

<https://docs.google.com/forms/d/e/1FAIpQLSf93NKEHCYnTwisyrl6Bbb1ul8YWs6tYrv-LvNRAkW3EOkPeg/viewform>

[https://drive.google.com/file/d/1ynZ5k7ABh0JoAI54A-s\\_pNta1HomPlhp/view?usp=drivesdk](https://drive.google.com/file/d/1ynZ5k7ABh0JoAI54A-s_pNta1HomPlhp/view?usp=drivesdk)

دعواتكم