

What is the mode of inheritance?

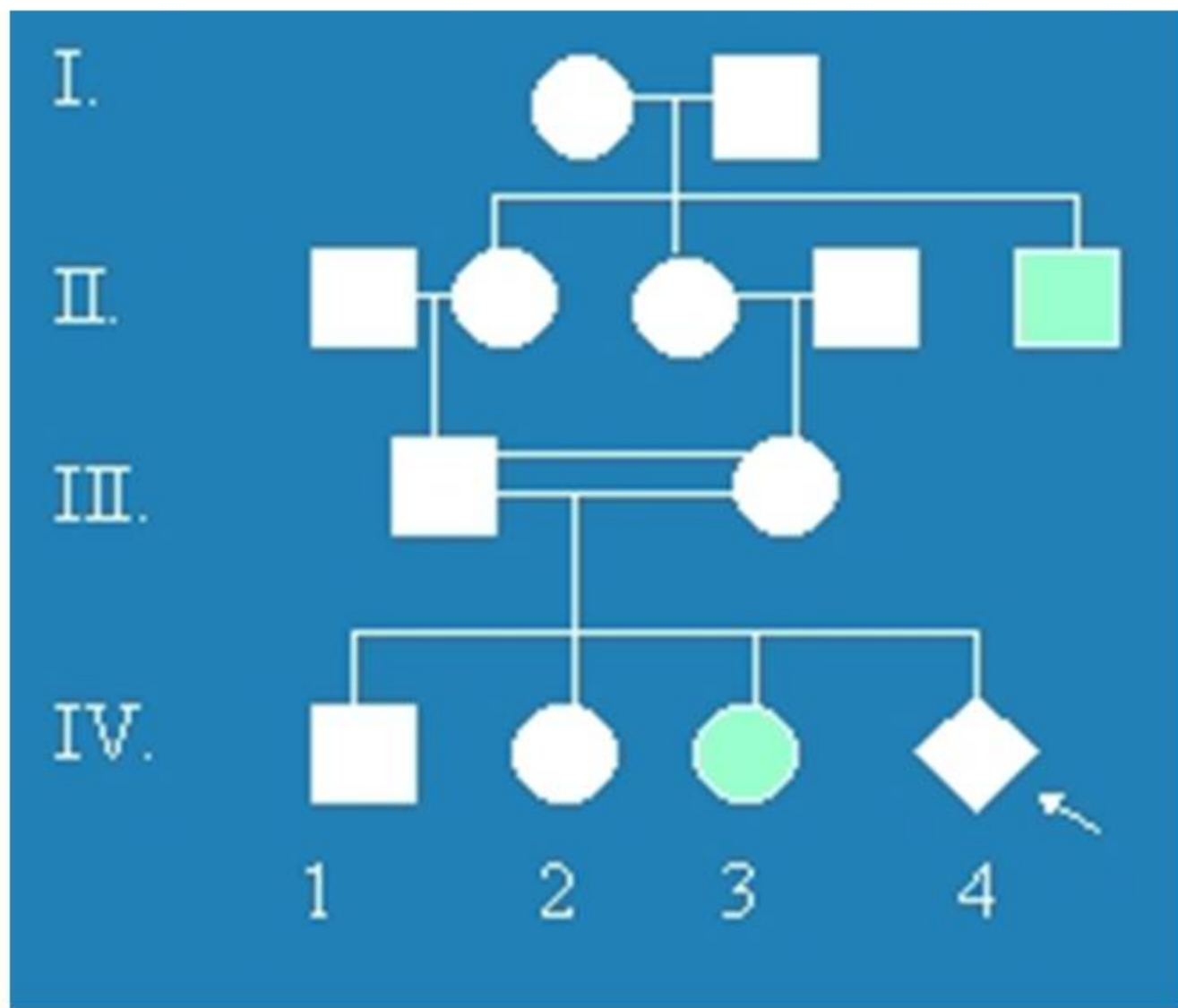

What is the mode of inheritance?

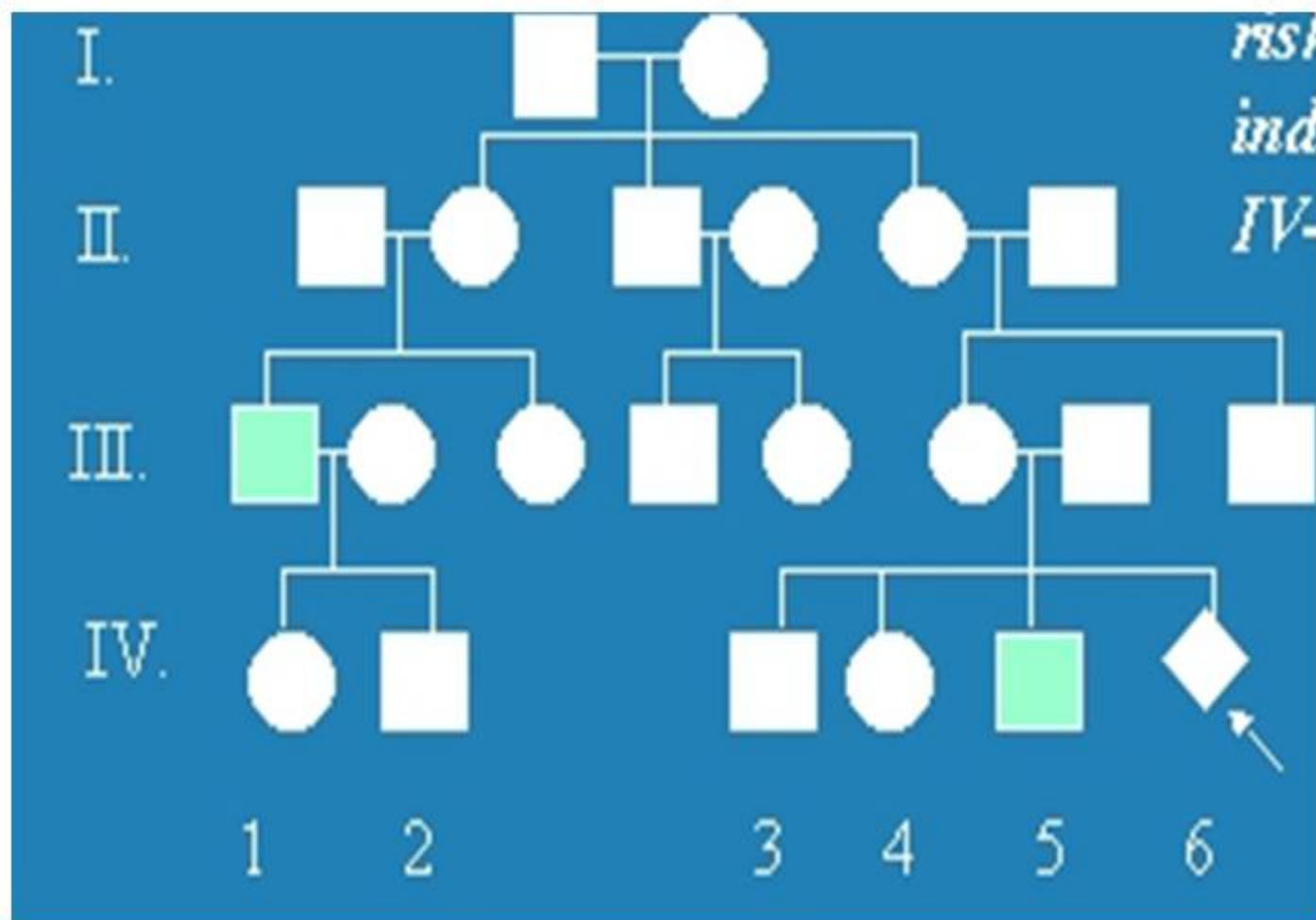

What is the mode of inheritance?

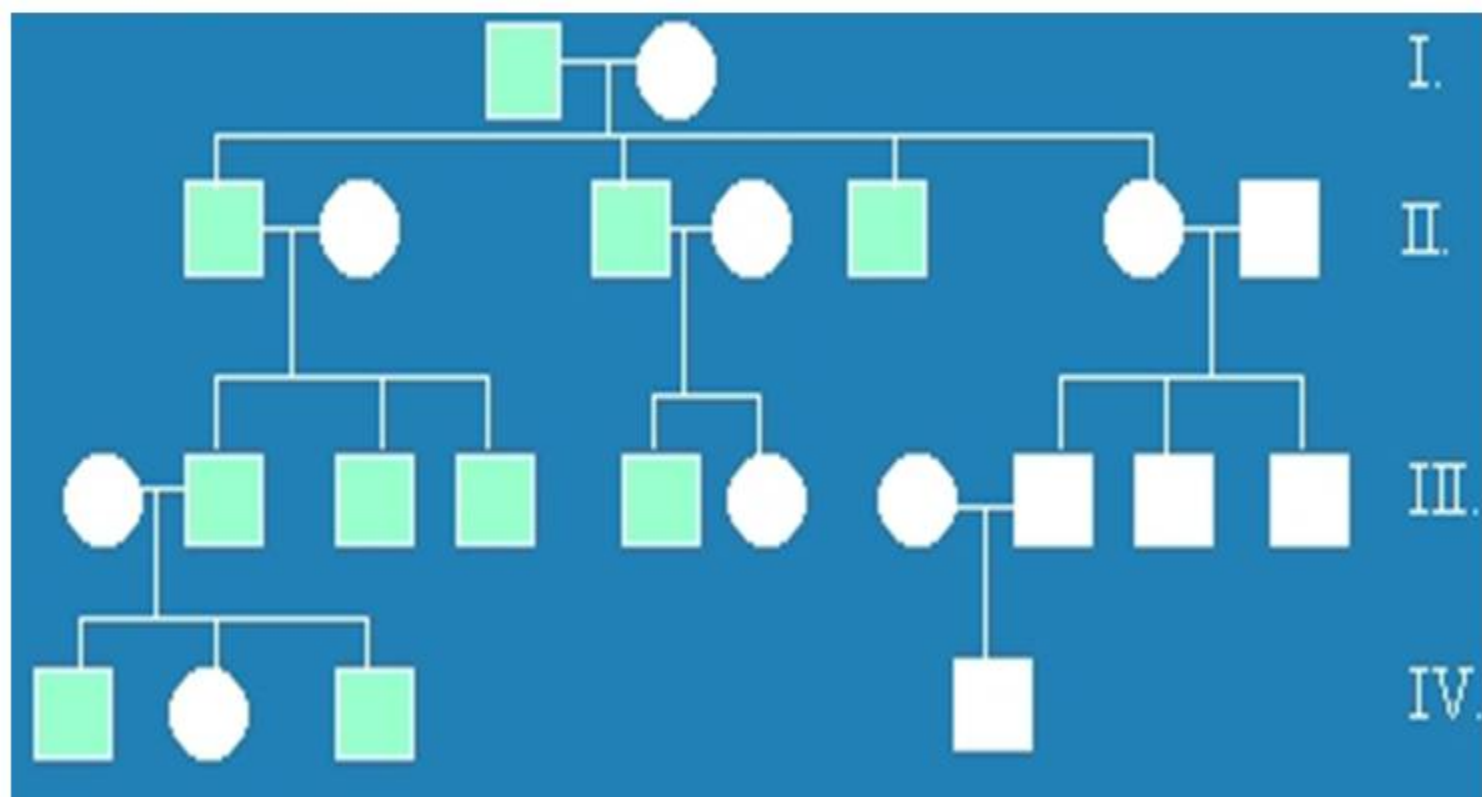

What is the mode of inheritance?

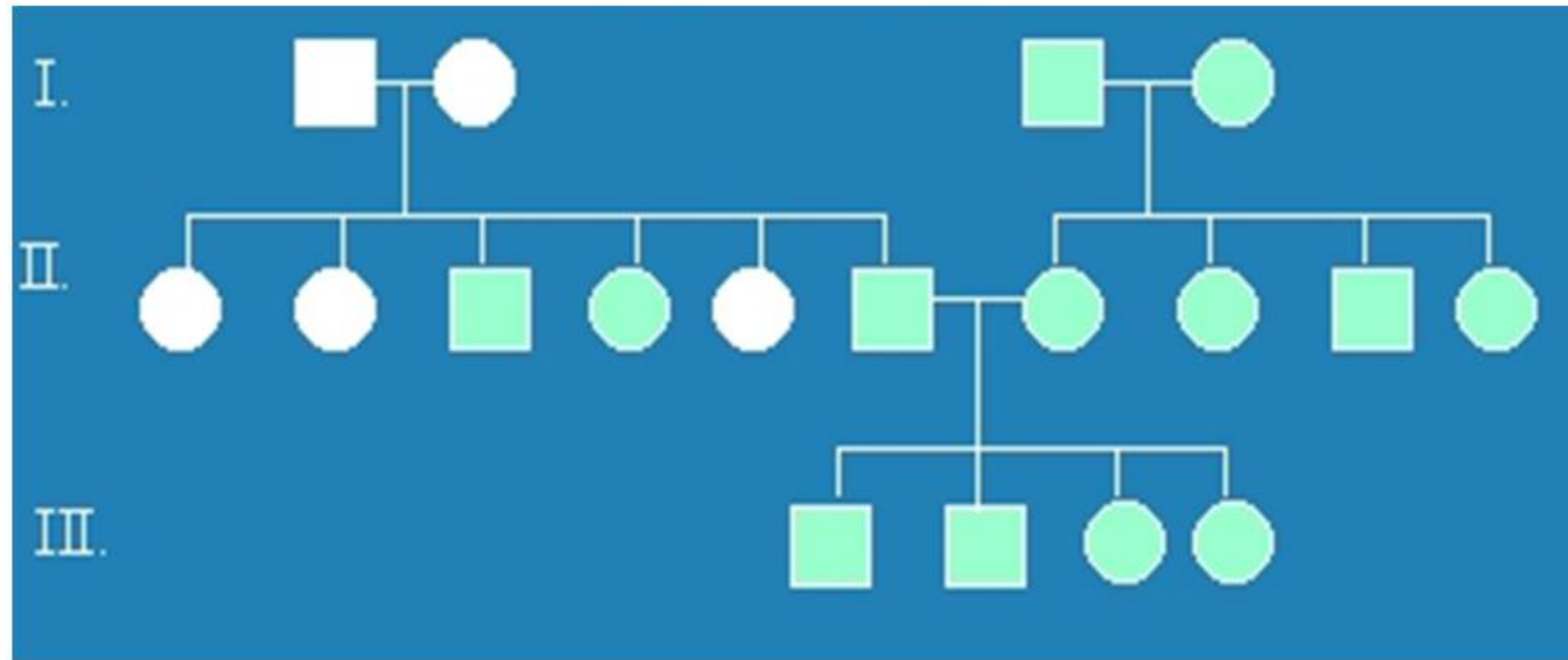

What is the mode of inheritance?

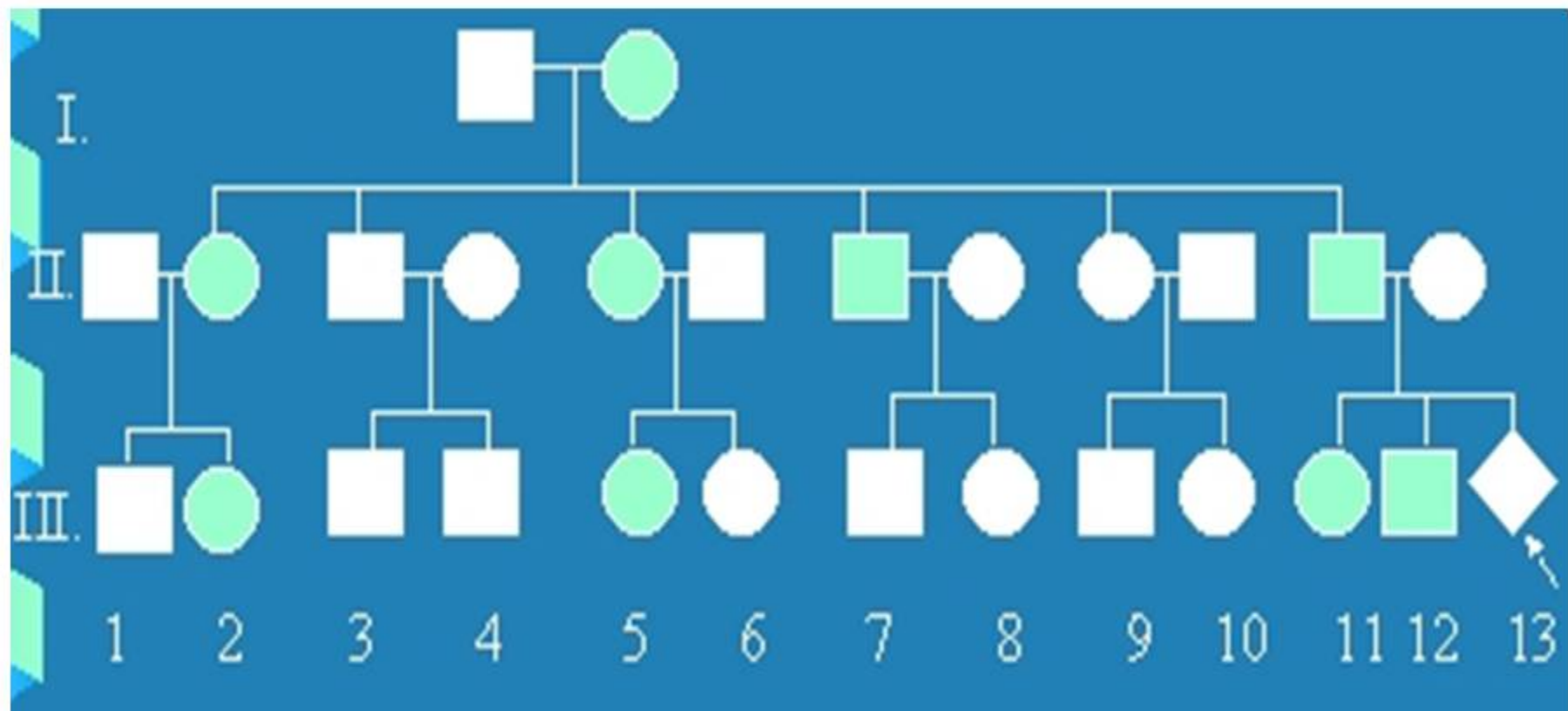

What is the mode of inheritance?

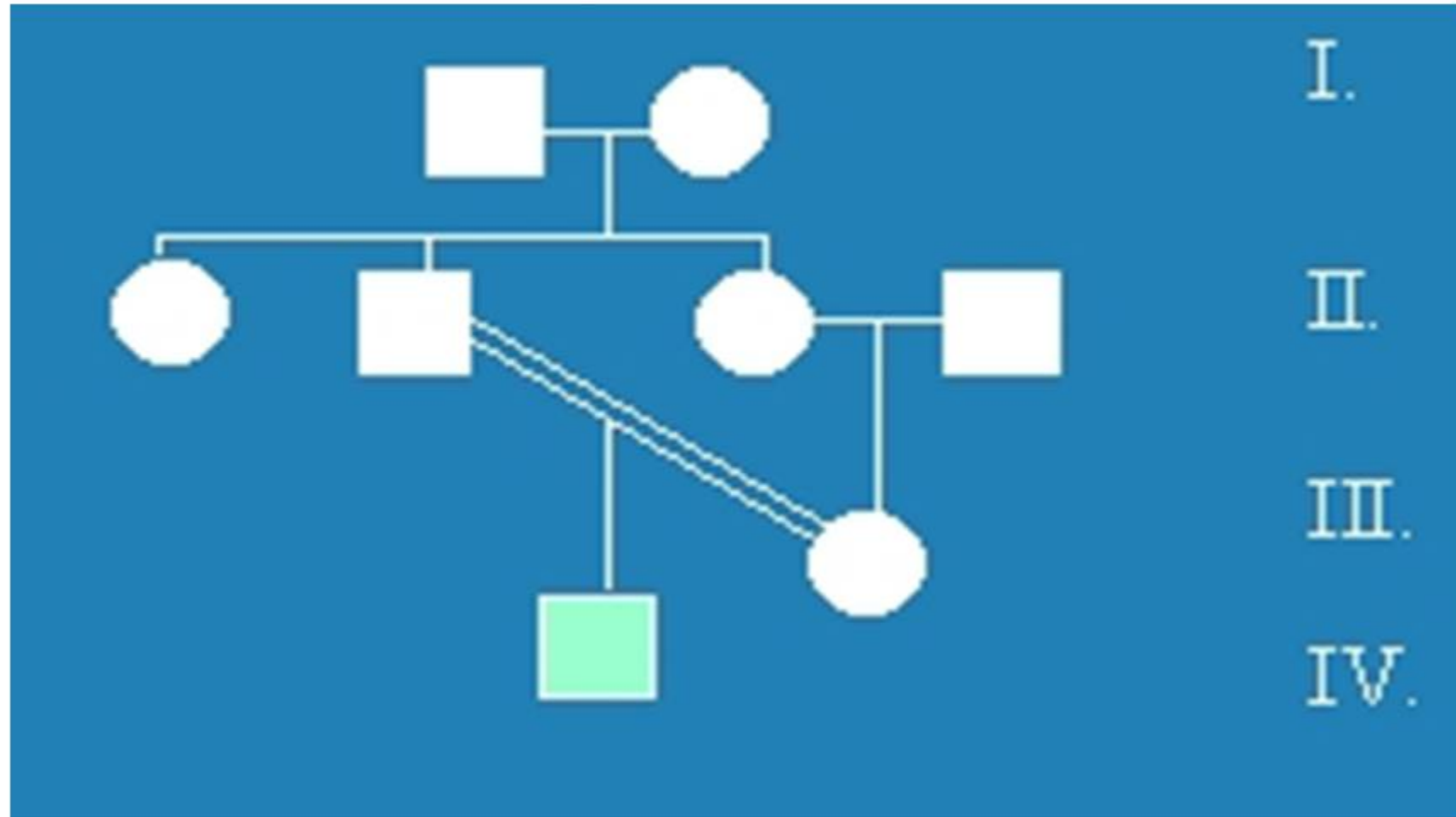

What is the mode of inheritance?

Autosomal recessive

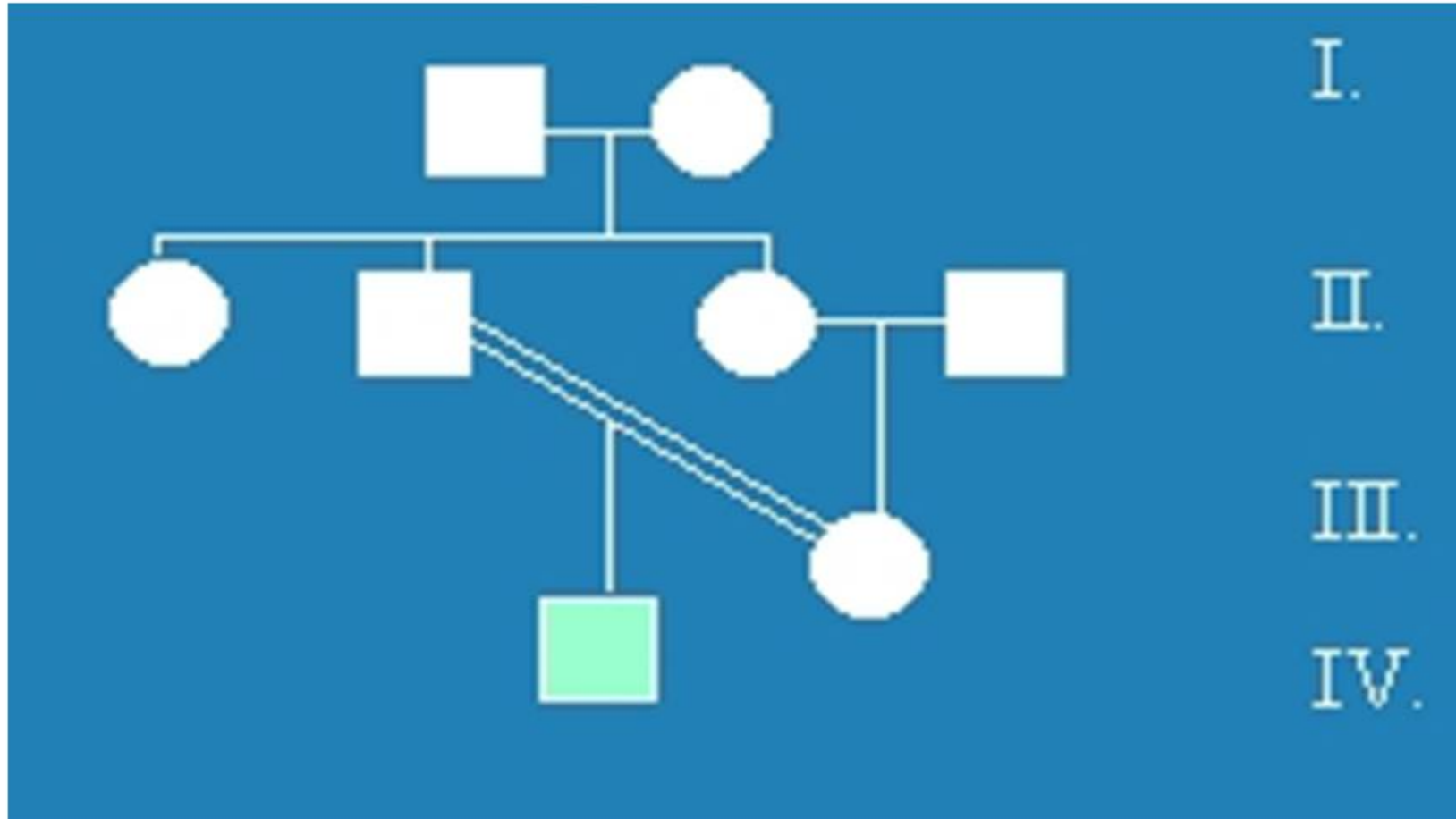

What is the mode of inheritance?

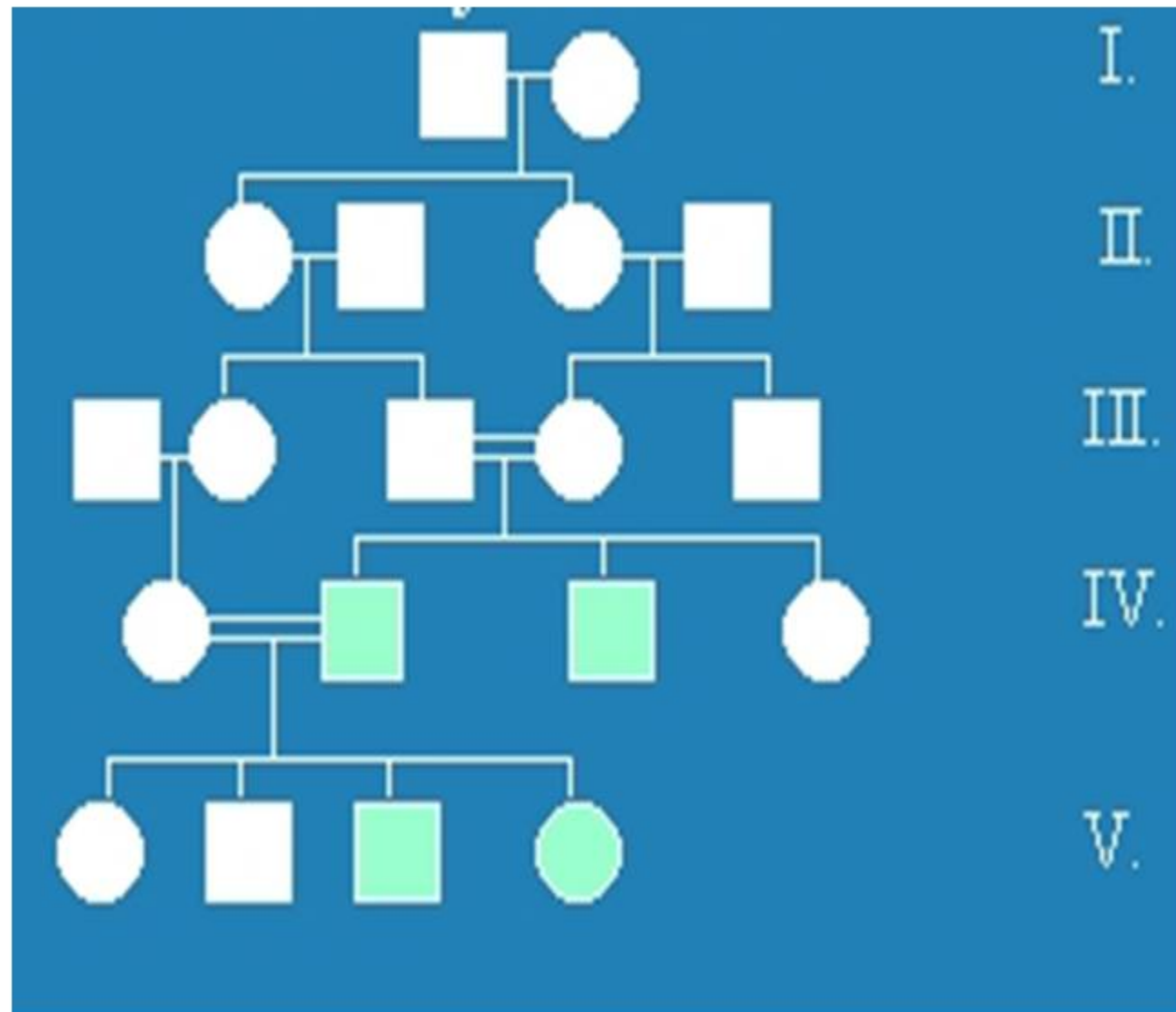

What is the mode of inheritance?

X-linked recessive; inbreeding shows apparent male to male transmission

